

How to build a fibre network

Developer Guide

Version 9.6 • May 2022

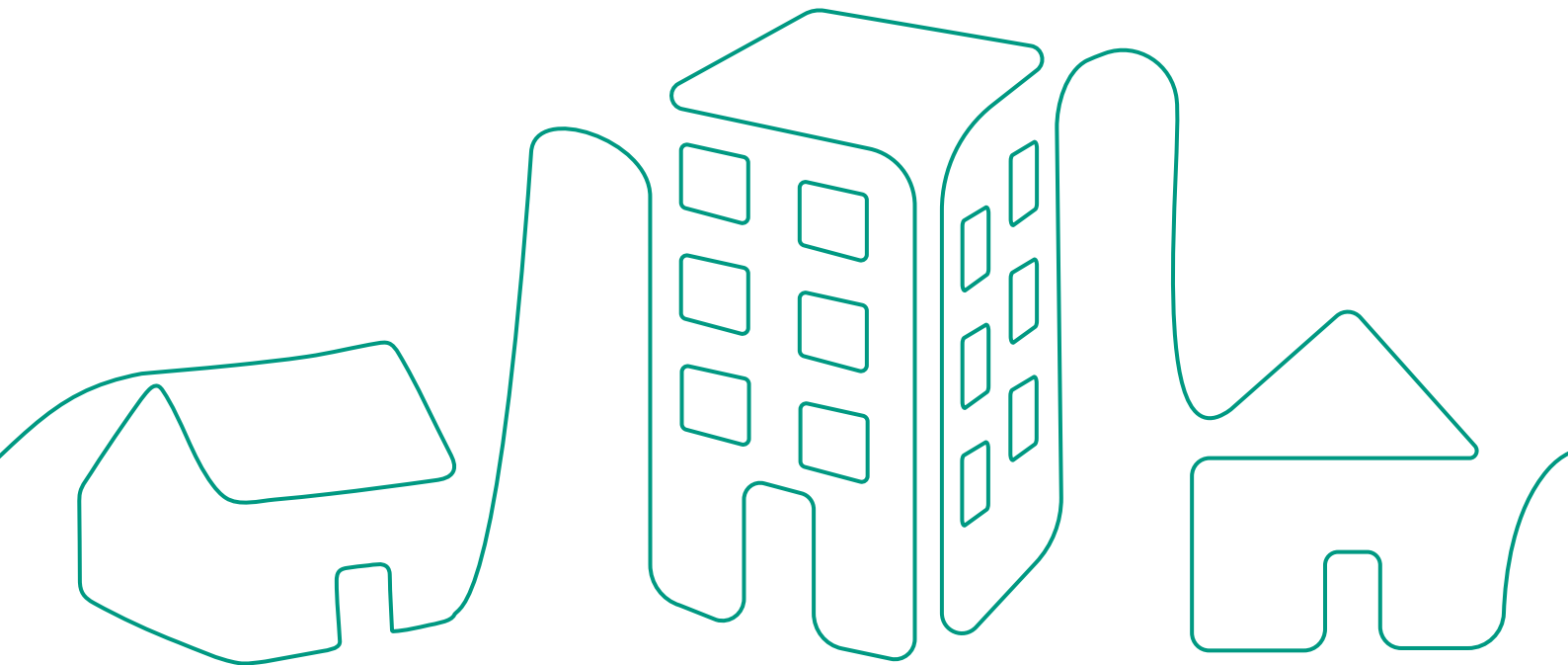

Contents

01 Internal equipment	04
02 Home wiring	06
03 Developer self-install	11
04 Cabling and ONT positioning	14
05 Single dwelling units (SDUs)	19
06 Multi dwelling units (MDUs)	21
07 Commercial units	25
08 Duct laying	28
09 Modular jointing chambers – Quadbox™	32
10 Joint boxes, footways and frames & covers	35
11 List of abbreviations and acronyms	41
12 Health and safety advice	42
13 Quality control checklist	44
14 ONT plot stickers	48
15 Physical Infrastructure Access (PIA)	53

Copper lines on Openreach New Sites

Openreach has announced its plans to ‘switch off’ the traditional analogue (PSTN) Copper network by the end of 2025.

Between now and then, Openreach will move tranches of exchanges into a ‘stop sell’ position when 75% of addresses in an exchange area can get Ultrafast Full Fibre broadband (also known as Fibre to the Premises or FTTP). This allows us to stop selling Copper WLR and PSTN products to Communication Providers (CPs) at those addresses.

For new sites we want to ensure that we only build one infrastructure which is Ultrafast Full Fibre. We want to remove the dependency on providing small amounts of Copper solely for the purpose of special service lines and from 15 November 2021 Openreach New Sites no longer offers additional Copper for the sole purpose of service lines.

Your equipment providers or CPs should be able to supply an All-IP or GSM based solution for existing Copper reliant services. Please contact them directly to organise these solutions which will allow your sites be fully FTTP serviced.

More information about Copper and FTTP Service Lines on New Sites can be found on our website: openreach.co.uk/propertydevelopment

1 Internal equipment

Openreach Optical Network Termination (ONT) and enclosure

The ONT is the Openreach demarcation point. It replaces the traditional copper master socket.

The Openreach ONT can be housed in an optional enclosure providing space to manage the wiring, keeping everything neat and tidy. The enclosure is designed for simple wall mounting with just two screws. This enclosure can be ordered by your FBC if required.

- Optical port connects to the single ended internal fibre cable (ezbend)
- Ethernet port connects to the communications provider's (CP) router.

Huawei 1+0 ONT



Nokia 1+0 ONT



Internal equipment



The enclosure fits over a standard single or double back box, with mounting holes that allow horizontal mounting over a double back box or vertical mounting over a single back box.

Both ONTs shown on the previous page share roughly the same dimensions, making the enclosure able to mount either ONT option.

Please note

The 1+0 ONT no longer contains an Analogue Telephone Adapter (ATA) which converts digital signal into traditional telephony dial tone. Telephony over fibre is now the responsibility of the communication provider, and the home owner may need to plug their telephone into the communication provider's router.

Homeowners should speak to their chosen service provider about the specifics of voice over fibre when ordering their broadband service.

2 Home wiring

The wiring that you install in your customer's properties is pivotal to their experience.

Your internal wiring installation options are shown below

Implications of locating the communication provider's (CP) router in a cupboard

It is important to note that the Wi-Fi service your customer receives is dependent upon the intended location of the CP router. Placing the router in a service cupboard or under stair cupboard will significantly reduce the speed and coverage your customer will receive.

It is highly recommended that if you position the router in this way that you provide additional RJ45 ports within the home.

Ideally for optimum speeds to be enjoyed using Wi-Fi it is recommended that you locate the router centrally within the property.

For information, advice and guidance around positioning, please refer to: PAS: 2016 Next Generation Access for new Build Homes Guide.



Please note

All internal wires and sockets beyond the ONT are the responsibility of the developer/future homeowner.

If any part of the single ended internal fibre cable (ezbend) is found to be damaged at commissioning, it is the developer's responsibility to replace it.

If the homeowner experiences a lack of service or poor service, due to a fault within the internal installation of wiring, which requires Openreach to rectify, the homeowner will be charged.

Please note

All installations of an Openreach ONT require at least 1 power socket to be installed/available in the same location.

An additional socket is recommended if not provided RJ45 network ports throughout the home, as this will be required by the CP router.

Home wiring

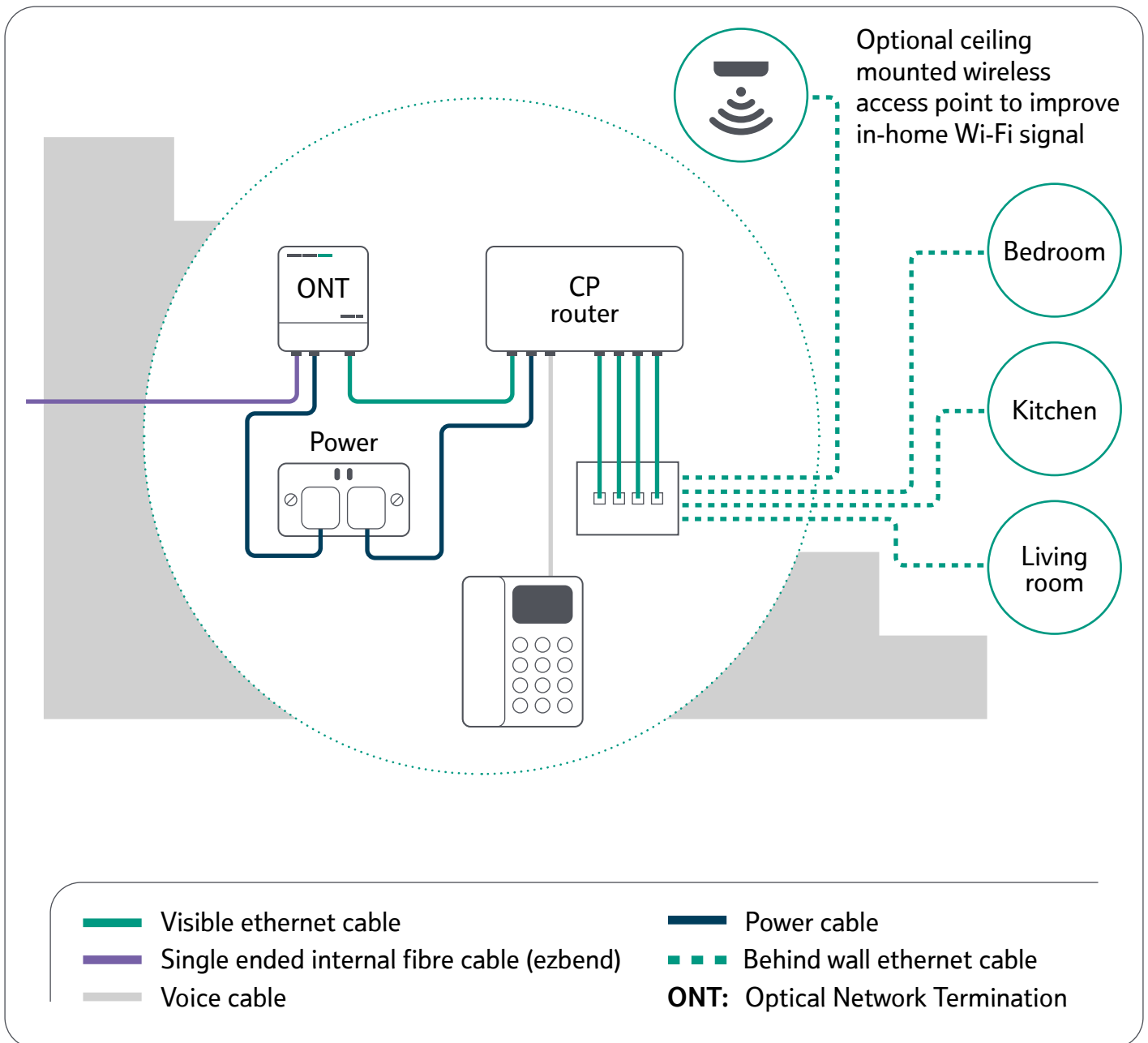

Option 1: The simple install

The simplest installation involves the provision of the Openreach equipment (i.e. the ONT will be positioned adjacent to the outside wall) to which the customer then attaches the router, provided by their communications provider (CP).

This installation limits the number of physical connections to the router and means the homeowner may not make the most of their FTTP connection due to the reliance on wireless connectivity.

Home wiring

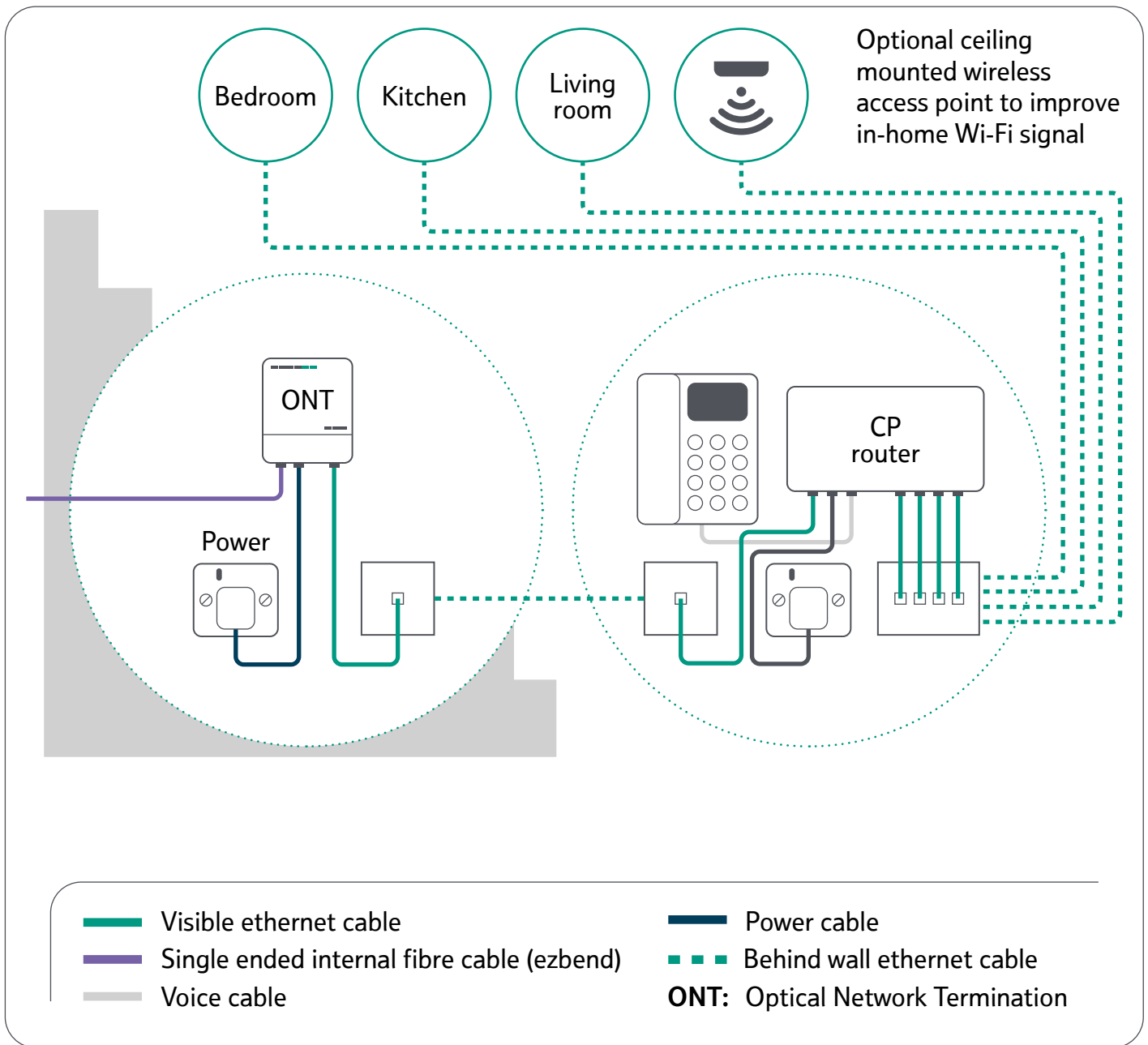

Option 2: Relocating the router via internal network cabling

Relocating the communications provider (CP) router provides a better quality wireless connection, as well as the ability to connect static devices such as TVs or games consoles physically. This allows these devices to take full advantage of the high speeds and bandwidth of a Full Fibre connection. Additional Cat6* cabling is required for this option from the ONT to the chosen relocation area. This connection should terminate in an RJ45 socket. A power socket should be provided for the CP router next to this socket.

*Cat6 is the preferred option to 'future proof' for modern devices

Home wiring

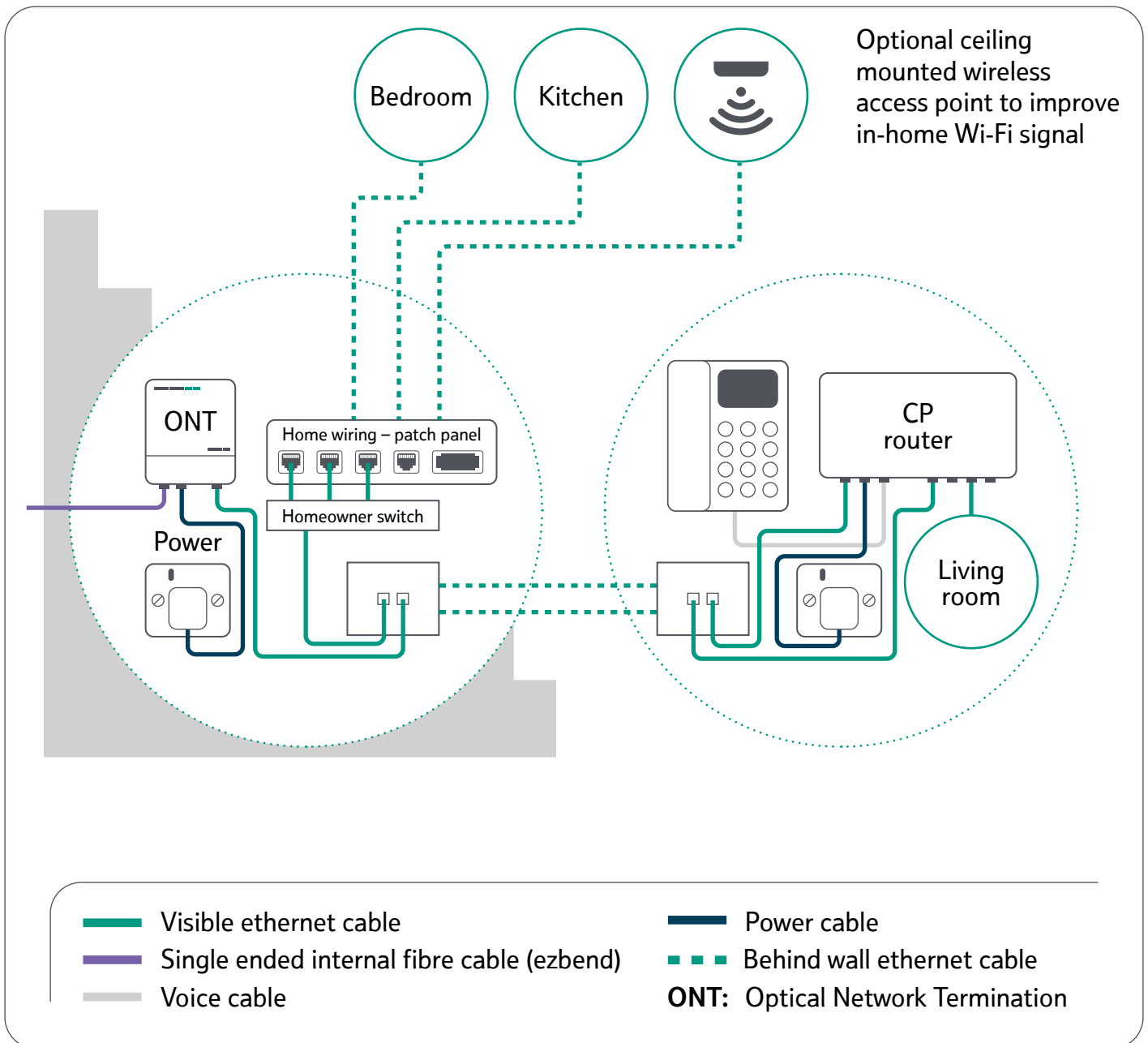

Option 3: The networked home

Further to the second option, this setup cables back from the CP router position within the property to the under stairs/service cupboard position of the Openreach ONT for the location of a patch panel. This means that, as much as possible, any structured cabling is discreetly located out of sight.

A patch panel is the best option to intelligently connect multiple rooms with structured cabling. In this setup a customer could also install an ethernet bridge/switch to further create a truly networked home.

Home wiring

Provision of the Openreach equipment

When Openreach installs the equipment we will install the ONT wherever the incoming fibre cable is located. Where you self-install the ONT, you will have control over when the equipment is installed. The ONT will remain the property of Openreach in both installation scenarios.

Where you are self-installing the Openreach equipment we will supply the ONT and the single ended internal fibre cable (ezbend) you need.

If you are installing the ONT opposite the cable entry hole, you will need to install a flush mounted double back box on the internal wall where the ONT is to be located.

The ONT will be installed at this location unless an alternative position has been agreed with your Field Based Co-ordinator (FBC) and the appropriate single ended internal fibre cable (ezbend) is run in a continuous fault-free length to the alternative position.

Please note

If single ended internal fibre cable (ezbend) is damaged by developers during installation then an internal Splice Point may be required to be fitted to complete installation. This will be undertaken at commissioning stage by Openreach.

Installation of internal cabling

Data cabling recommend

With the shift to full fibre networks, traditional analogue voice services are being phased out. A full fibre network transmits a digital or All IP signal rather than analogue.

In addition, the latest Openreach ONT variants no longer come with an integrated ATA (Analogue Telephone Adaptor). Some CPs may provide an ATA port on their router, but this is dependent on the individual CP and therefore Openreach cannot guarantee the availability. Therefore, we strongly recommend against installing traditional analogue voice cabling and extension sockets around your new build.

Instead, Openreach highly recommends substituting with data cabling. This gives the future homeowner the flexibility to use the extension for data or, by using their own customer procured ATA, traditional voice services.

It's worth noting that most CPs are recommending their customers use VOIP (Voice Over IP) equipment for voice calls rather than ATA's to convert the FTTP IP signal to analogue. Homeowners can contact their CPs to find out more about the options for voice services.

3 Developer self-install

- As a rule of thumb, single ended internal fibre cable (ezbend) must not exceed the minimum bend radius (i.e. no smaller than) of a £2 coin.
- Detailed information on cable installation and separation is given in the British Standards Code of Practice 6701, Part 1 (particularly clause 6) and the relevant sections of the latest IEE Regulations for electrical installation (Regulation 525 is of particular importance).
- The wiring pattern for cabling must be either series or spur for voice cabling and point to point for data cabling.
- We'd recommend data cabling rooms likely to benefit most from a physical connection, like the room with the main TV and the home office.

Internal Work at defined ONT and Communications Provider router position

- Fit the electrical socket to the wall.
Only a single socket is required for the ONT, however a double socket is recommend if placing the communication provider router next to the ONT.
- Fit the double back box to the wall.
- Fit the slave voice socket to the wall (can be modular to house one voice port and one data port).
- Fit RJ45 modular boxes. The number of these are to be determined by you, the developer, Openreach recommend a minimum of two are fitted, one for the communications provider router and the other to the room requiring streaming media for example for streaming high definition TV. See the internal wiring section for further information.
- All internal wiring to be run back to this point (daisy chain for voice and point to point for data).
- See below for the recommended layout of sockets on the wall, the layout can be mirrored.

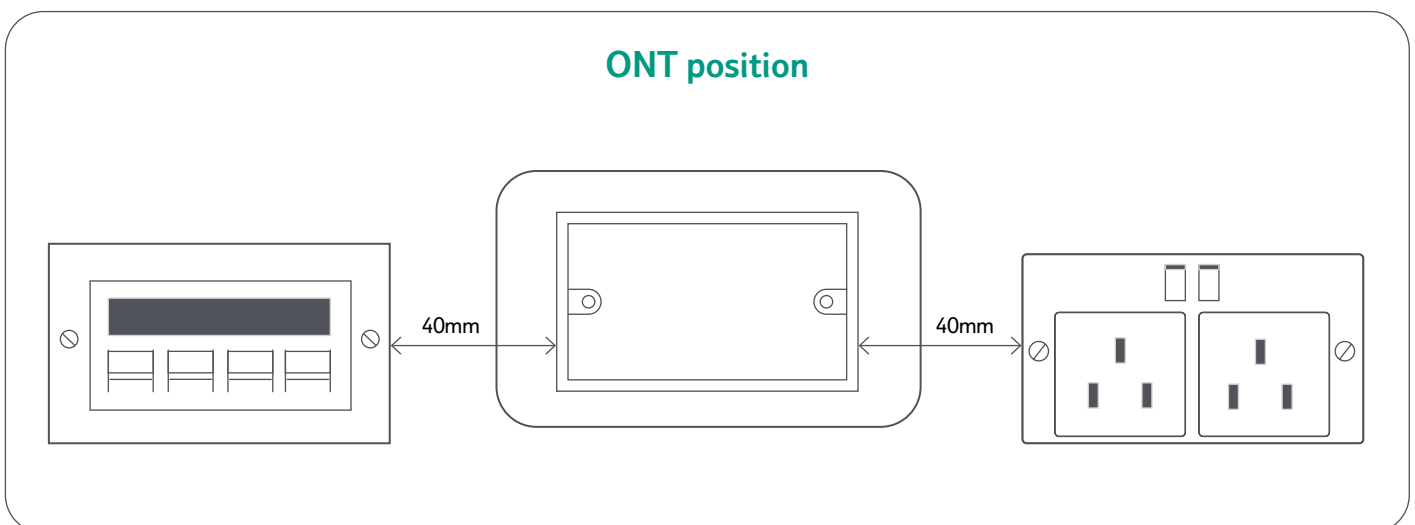

Developer self-install

Single dwelling unit at second fix (Internal Work)

- Remove the double back box faceplate and feed the fibre cable through the large hold in the back of the casing.
- Attach the casing to the back box. If mounting over the back box is not an option, the casing can be attached directly to the wall using the supplied mounting template.
- Attach the ONT to the casing using the mounting pegs. If using a Nokia ONT, ensure the 3 spacer pegs on the casing are removed first.
- Clean both the pre-connectorised green end of the internal fibre cable and the Optical port of the ONT before inserting the cable.

A video showing the installation of the internal equipment can be found on the Openreach developer website:

openreach.com/fibre-broadband/fibre-for-developers/how-to-self-install-openreach-equipment



Remove the cap from the green fibre connector and the stopper covering the ONT port, disposing of both. Clean the now exposed fibre plug and the port of the ONT using a click cleaner or cleaning swabs.



More information about how to use these cleaning products is available on the Resources page of the stickler website: sticklers.microcare.com/resources/?fwp_resource_type=howto -can we do a friendlier URL for this?

Developer self-install

- Connect the ethernet cable to the PORT port on the ONT. The other end of this cable will be connected to the CP router or internal data cabling port.
- Connect the mains adaptor to the ONT and plug into the mains socket.



Next steps

- Once the plot is complete contact your Openreach FBC as each plot is ready for connection (i.e. front door on; power on, ONT area decorated).
- Your Openreach FBC will then raise a job with the Openreach teams to commission the plot(s).

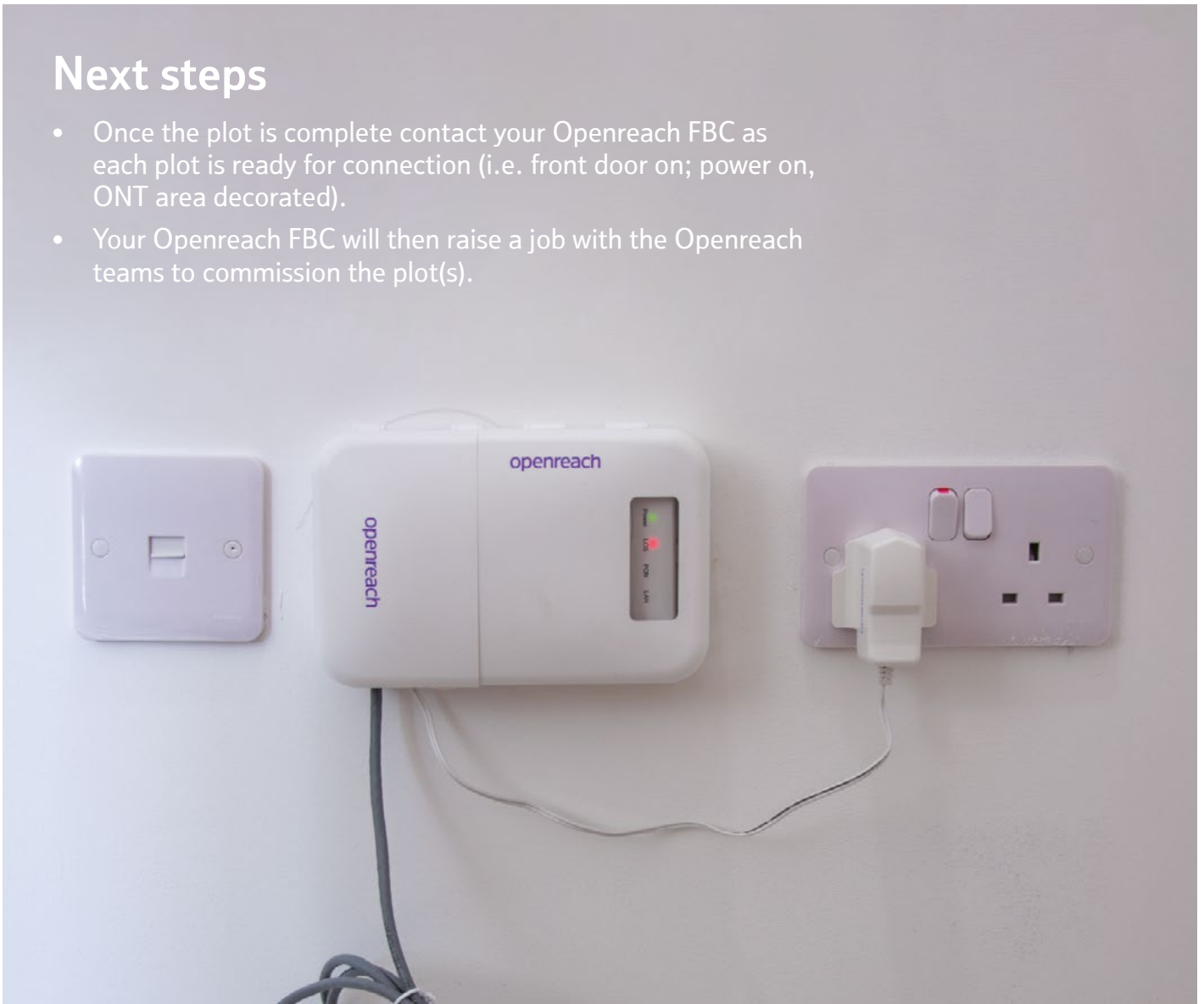

4 Cabling and ONT positioning

Single dwelling units

For single dwelling units single ended internal fibre cable (ezbend) will be available in different lengths (20m and 30m) and will be delivered on drums that can be ordered via the FBC.

Enough excess must be left coiled externally to allow connection to the cable coming from the duct, but without too much excess slack.

Around 2-3m of cable is required to be left coiled externally.

Once the cable is installed then Openreach (or their third party) will visit to connect the cables from the plot back to the serving splitter location(s), mount the external capping and then commission the plot.

Installation of pre-connectorised cable at first fix (Internal Work)

Coil 1m of the pre-connectorised end of the cable into the empty double back box, taking care not to damage the green connector, then fit a blanking plate to help protect the fibre. Ensure the cap on the end of the green connector is kept on during construction to avoid damage to the fibre.

The other (bare) end of the single ended internal fibre cable (ezbend) should be installed internally to externally, as only the green SC-APC connector needs to go to the ONT mounting point. Feed the cable through the external wall to the splicing point outside of the property, ready for Openreach to connect.

Around 2-3m of cable is required to be left coiled externally, the cable can be cut and the end covered with electrical tape if needed to keep the right amount coiled outside the house. Avoid leaving any unnecessary slack cable in the wall cavity of the house.



Above – Single ended internal fibre cable
Below – Connectorised end of cable coiled in back box



Cabling and ONT positioning

Complying with building regulations

Even where you are not working with Openreach or another infrastructure company to provide a functioning broadband and phone infrastructure to the home, the Part R regulations require the provision of duct in the default position discussed below so that infrastructure can be installed in the future.

ONT in the default position

When the ONT is to be fitted in the default position on an internal wall directly opposite the entry position of the service access hole adjacent to the external duct location, external capping will be fitted on completion.

To keep things tidy, make sure that the service access hole is drilled in line with the duct and in keeping with the dimensions shown opposite.

The service will be sealed with a grommet or mastic before fitting the external capping.

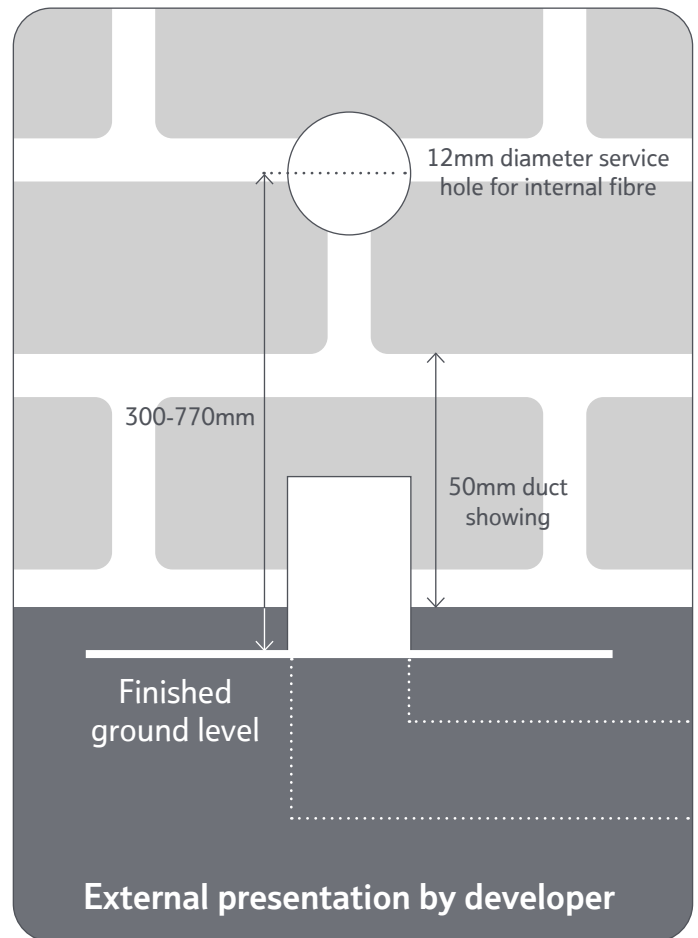

Please note

All internal wires and sockets beyond the ONT are the responsibility of the developer/future homeowner. Any faults or defects resulting in an Openreach visit may incur a charge.

Cabling and ONT positioning

Wherever possible, the duct shall be positioned on the opposite side of the wall to where the ONT will be installed, removing the need to run internal fibre cables.

However, there are cases where the kit will need to be installed away from the external lead in and your FBC will be able to advise.

ONT installed inside the house (non-default position)

When the ONT is to be fitted in a non-default position i.e. not directly behind the external entry point, such as in a utility cupboard, the above guidelines must be followed to provide entry of the cable into the home.

What will be different is the length of cable that will run from the entry point into the building to the Openreach ONT. In this case you have the responsibility of running the single ended internal fibre cable (ezbend) required inside the house in such a way that it is undamaged and complies with building regulations for the installation of telecommunications infrastructure cabling.

The same rules apply to the running of fibre cable internally that are specified in the section on exterior ducting. For example, the installation of the fibre cable in protective conduit and the absence of a bend more than 90°. Once installed the ONT must be kept powered on.

If this option is followed but the cable is found to be damaged once in situ during construction work inside the property, cables must be replaced before the fibre service can be tested and called off by your Openreach FBC.

The developer must run the single ended internal fibre cable (ezbend) in a continuous length, ensuring it remains free from any damage that could reduce the lifespan of the cable, and keep the capping on the connectorised end of the cable until the installation is complete.

Enough excess must be left coiled externally to allow connection to the cable coming from the duct, but without too much excess slack. Around 2-3m of cable is required to be left coiled externally.

A 1m portion of the internal cable should be left coiled and housed within a flush mounted double back box and faceplate ready for Openreach provision of the ONT.

It is important to select the right cable to achieve the minimum excess slack. Any unavoidable extra slack should be stored in a no drill zone wall cavity, taking great care not to loop the cable tightly as this will cause the cable to fail.

Cabling and ONT positioning

Interconnecting voice lead (Item Code 077004) will be provided free of charge by Openreach. It provides connectivity from the ONT to a co-located voice socket/patch panel. On installation it becomes the property of the homeowner. Alternatively, the developer may choose to hardwire directly into a voice socket using a 431A Plug.

Multiple dwelling unit (external)

- Fit all external duct from the site connection point to the building entry position.
- Fit all tray work from the building entry position to and up the risers to the internal splitter position(s).
- Run the fibre cable from the splitter or fibre node/budi location to (and in) the riser to the communications room.
- Coil a minimum of 2m in the communications room.
- Coil a minimum of 2m at internal splitter position.
- Ensuring bend radius of cable must meet all necessary installation requirements i.e. no 90 degree bends (as per current copper process).
- If the risers are away from the point of entry but fed through a vented car park then the external cable can be fed on tray work.
- If the risers are away from point of entry and fed through a non-vented car park then an area needs to be allowed within 2m of point of entry to change from external to internal cable.

Multiple dwelling unit – Next Steps

- Once ductwork and cable has been run from communications room to Fibre DP/budi – contact FBC to gain confirmation that all cables are run correctly.
- FBC will then raise a job with the Openreach Internal teams to commission the splitter(s).
- Once commissioning is complete contact FBC as each plot is ready for connection (front door on, power on, ONT location is decorated).
- FBC will then raise a job with the Openreach internal teams to commission the plot(s).

Fire stopping compartment penetrations

All holes drilled through floors and fire compartment walls must be fire proofed using correct materials to prevent the spread of smoke in the event of a fire. Openreach can provide these materials in either cartridge (similar to silicone sealant) or putty form.

Cabling and ONT positioning

Fixing cables securely

If you're running any cables through a fire protected area like a fire escape route, escape staircase or walkway, the cable must be adequately secured using non-combustible fixings.

Wiring regulations must be followed, ensuring that wiring systems in escape routes are supported in such a way that they will not be liable to premature collapse in the event of fire. This applies to all cabling and not just electrical cables e.g. alarm, telecoms and control wiring. From January 2019 this will apply throughout the installation as the 18th Edition wiring regulations come into force.

Issues with home wiring

- Single ended internal fibre cable (ezbend) too short, cut or damaged.
- Defective or damaged home wiring creating a fault on the line.
- Extension sockets not connected to Openreach ONT.
- Bending radii exceeded causing reduced levels of service due to fibre being broken or the bend was too tight.
- Incorrect cable type or wiring configuration.

Impact on delivery

- Inability for Openreach to provide service and developer requirement to re-provide single ended internal fibre cable (ezbend).
- Poor user experience for home purchaser with possibility of Openreach charges if called upon to rectify.
- Slower data download speeds experienced.

Impact on delivery of issues

- Delay in completion – Openreach may refuse to cable if we can't guarantee adequate protection.
- The capping and covers would look unsightly.
- Failure to provide conduit can prevent a cable from being installed.
- Customers may not be able to place orders and remedial work may incur additional costs.

5 Single dwelling units (SDUs)

Standard SDU Installation

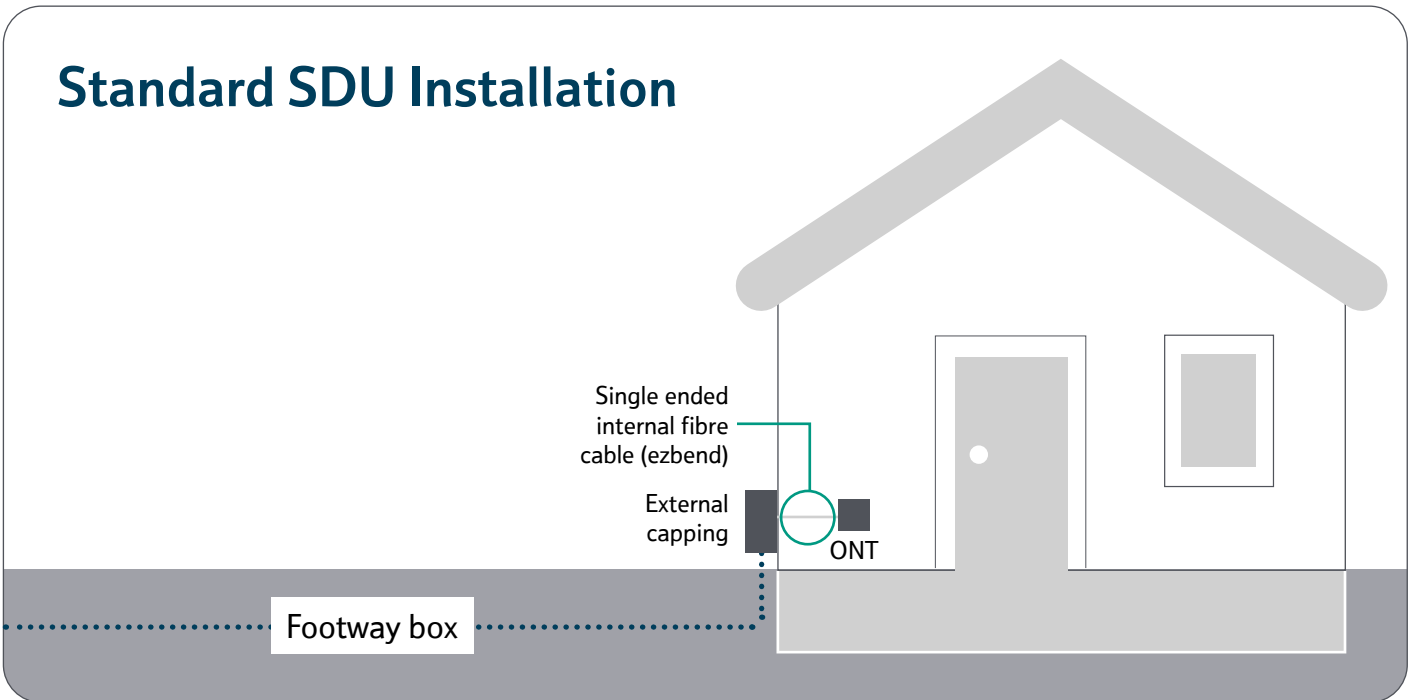

Maisonettes

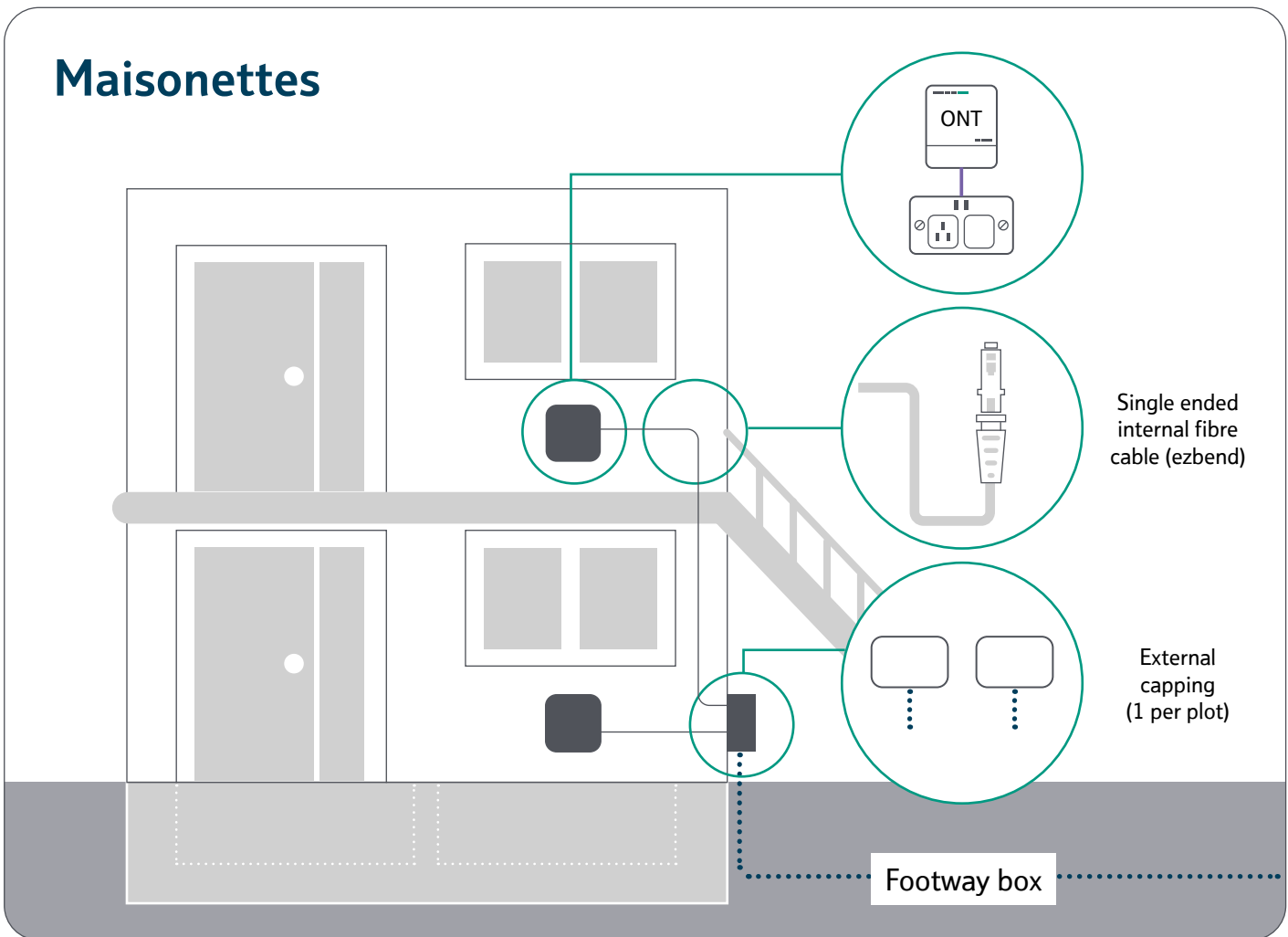

Single dwelling units (SDUs)

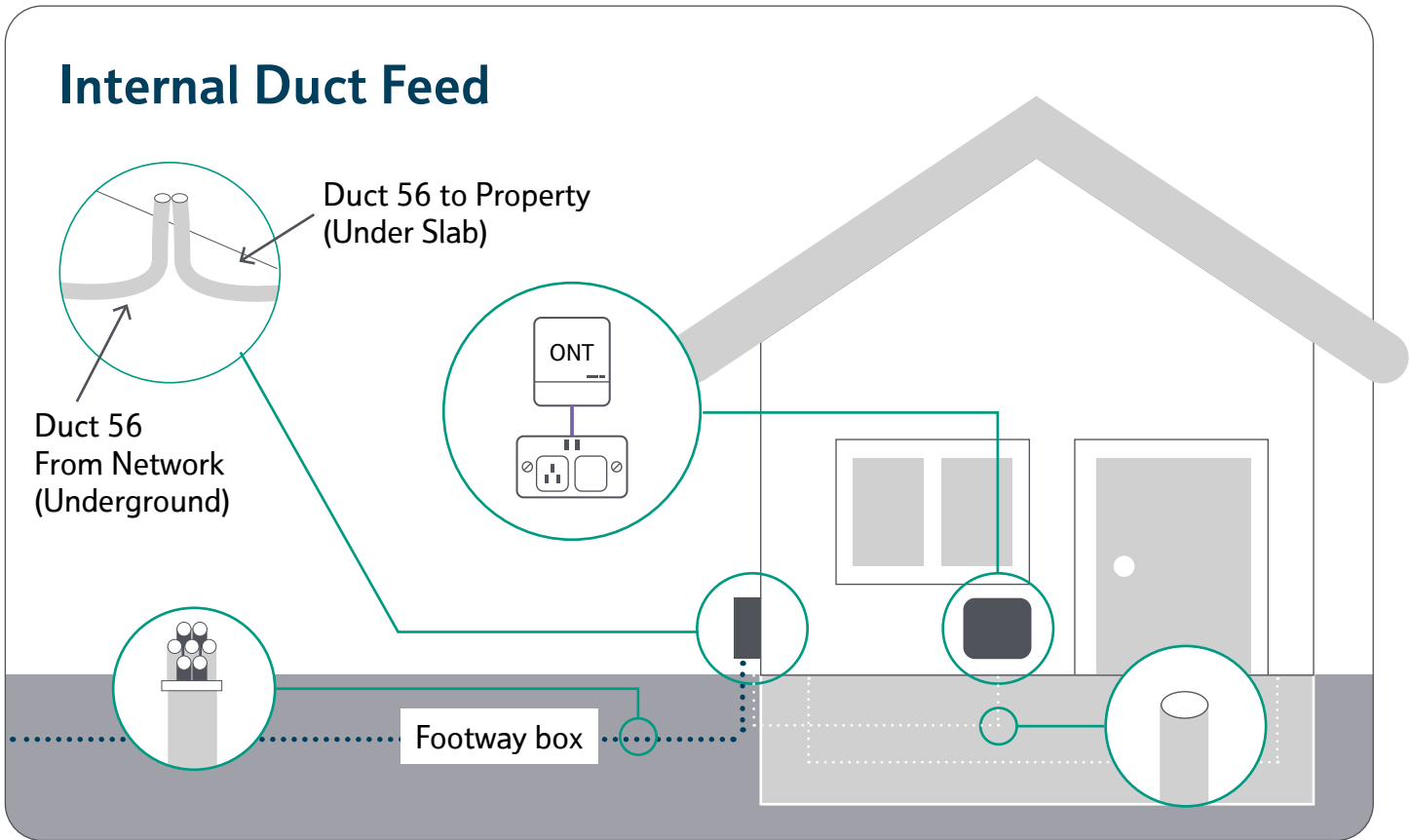

If internal duct feed to SDU plots is provided then under no circumstance should a section of duct feed directly from the underground joining chamber to the inside of the house.

This is due to the risk of gas passing from the underground network directly into the house. Instead, Openreach will only support internal duct feeds where there is a separate duct section from the underground joining chamber to the exterior of the house and then a secondary separate duct which feeds under and then inside the house.

The two duct mouths on the external house should be located as close to each other as practically possible. Currently, Openreach does not have a double duct capping and cover solution, but we are trialling some designs with industry.

The only current solution is to provide two separate capping and covers side-by-side. Depending on the distance between the two cappings the fibre cable will be partly exposed on the outside wall of the house.

We are working closely with industry in regards to Modular and Passive Homes to ensure our installation methods comply with the building standards and methods being employed. If you are building houses of this type then we will develop a solution as part of the site design if our standard installation methods are not suitable.

Any internal duct feed must be sealed to prevent gas or water ingress. The required sealant can be provided by your Openreach FBC.

6 Multi dwelling units (MDUs)

Openreach will create a fibre layout based on your Mechanical & Electrical (M&E) drawings (on larger MDUs) of the MDU. The design will calculate the materials required to build the network. Your FBC is on hand to guide you through the ordering process to make sure the equipment is available when you need it. The incoming Duct 54 and fibre cable will terminate in the communications intake room or riser cupboard. This needs to be a secure and safe location with access for installation and any future maintenance visits.

Our fibre box/splitter needs to be installed at a minimum height of 200mm and a maximum of 1500mm.

Your FBC will agree the location with you. Connectorised internal fibre cable needs to be run from each plot to the fibre DP location or basement box, depending on MDU layout. A minimum of 3m of coiled cable needs to be left at the fibre DP, with 1m left at the plot end. On most MDUs a tail cable may be required to be run from the floor DP down the riser to the basement box. A wayleave may be required from the building owner prior to installing apparatus in common areas.

Any internal duct feed must be sealed to prevent gas or water ingress. The required sealant can be provided by your Openreach FBC.

Small MDUs

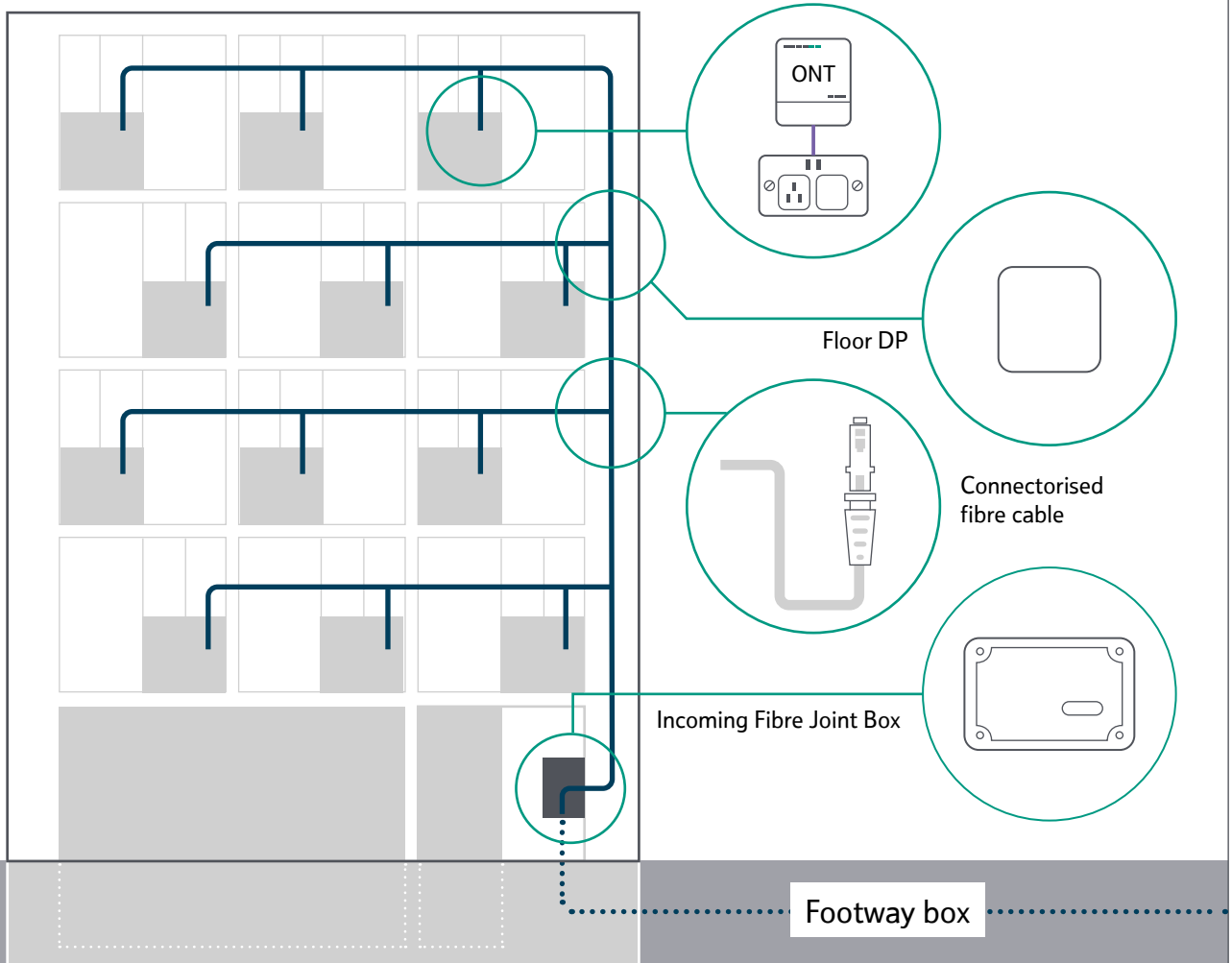

Multi dwelling units (MDUs)

BUDI (Basement) Box

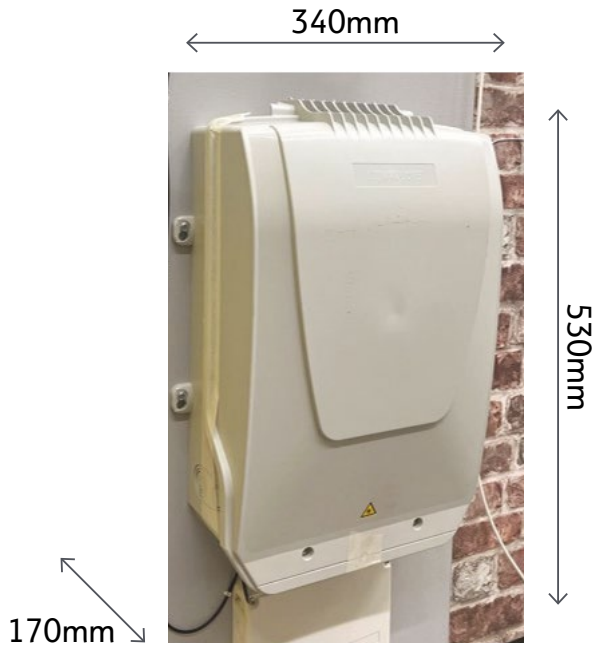

RDT (Riser) Box

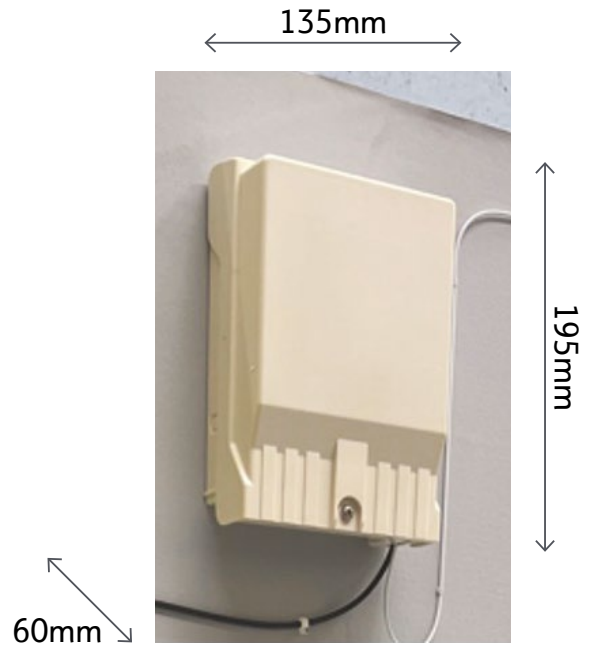

Multi dwelling units (MDUs)

Large MDUs

On most MDUs a tail cable may be required to be run from the floor DP (RDT) down the riser to the basement box

Connectorised fibre cable option for installing fibre in MDU

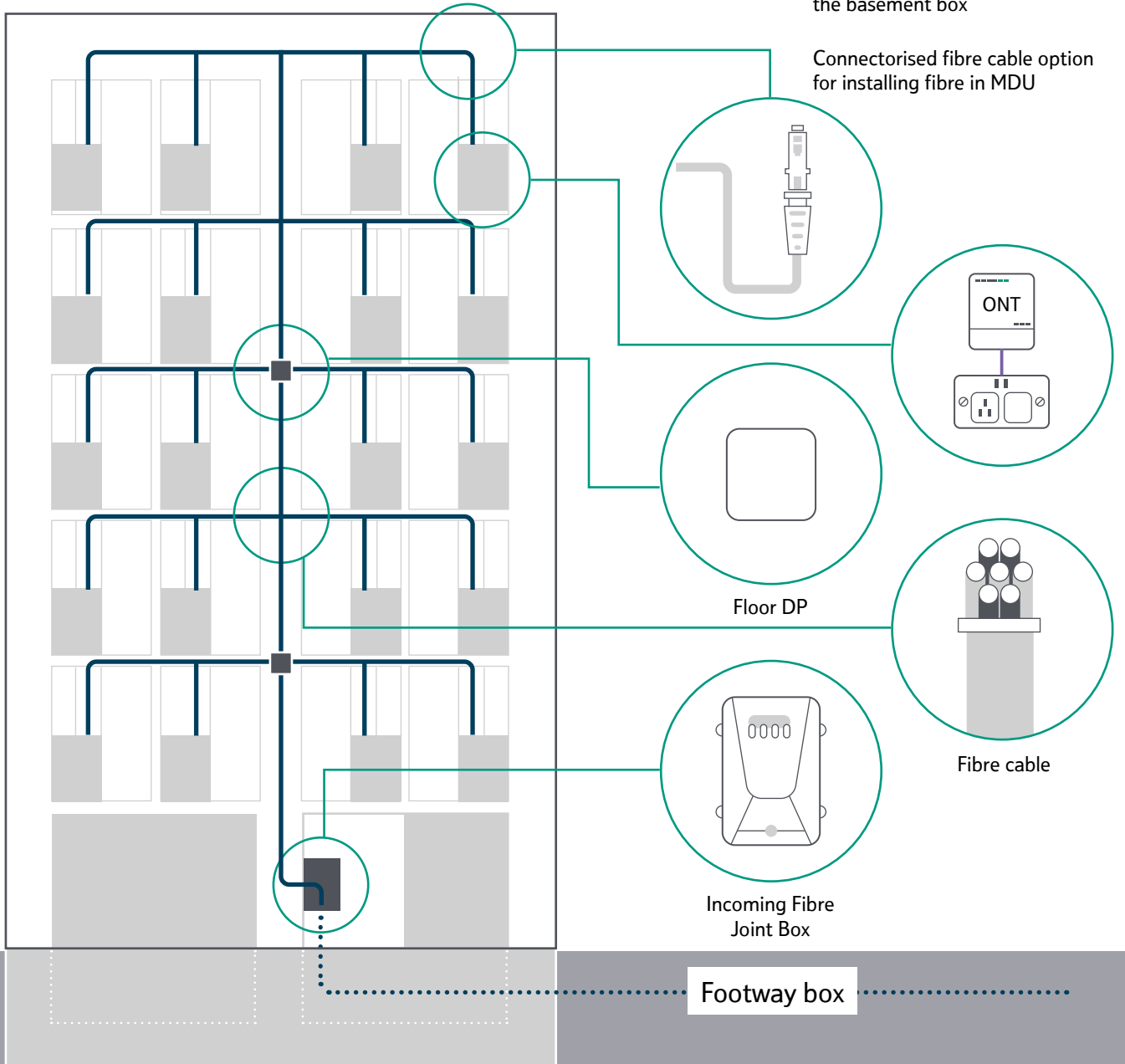

For larger MDUs there may be a requirement to install multiple fibre boxes and splitters.

These boxes/splitters will be connected with fibre cable commonly housed within the riser space.

Multi dwelling units (MDUs)

Option where Openreach installs the equipment

When Openreach is to install the ONT, 3m of cable is required at the splitter/ floor DP location and 1m (2m if non-connectorised cable) at the ONT end of the installation.

Each apartment will require a designated connectorised internal fibre cable run in a continuous fault-free condition from the designated ONT location within the apartment to the floor DP within the riser.

At the splitter locations the cable should be clearly marked with the apartment number and left safely coiled within the riser.

- Install a flush mounted double back box at the desired ONT location.
- Install the connectorised fibre cable from this point to the designated riser termination point.
- Ensure there is 1m of spare connectorised fibre cable protruding from the back box.
- Push some of the spare cable back into the wall void and coil the remainder inside the back box, taking care not to damage the connectorised end.
- Install blanking plate or brushed face plate to protect cable ready for provision of ONT nearby.

Bends in fibre cable must be kept to a minimum and the installation of trunking, cable trays/grids shall not compromise the bending radii.

Fibre cable containing no metal parts can be run on shared trays. Plate cable fixings with cable ties must be used to fix fibre cable direct to walls to avoid it being damaged.

Under no circumstances should cable or tubing be secured to or supported by the suspended ceiling hangers or under floor support legs. It is the developer's responsibility to provide fire stopping on completion of the cable/tubing installation.

Openreach networks must not interfere with or be interfered with by other services within the riser or any other shared space, such as:

- Un-insulated hot water pipes.
- Unscreened mains cables.
- Fluorescent lighting.
- Heavy duty switch gear.

A wayleave may be required from the building owner prior to installing apparatus in common areas. Remember you may need to order copper lines for commercial properties, for example lift lines.

Your FBC will advise of all cable marking/ labelling and will check for this when 'calling off' the work.

IET wiring regulations must be followed.

External cables can run to a maximum of 2m from the internal building entry point.

From this point onwards, all external cables must be terminated or transitioned to internal fibre cables to comply with Fire Safety Regulation BS7671.

Conduit or trunking must not be used to carry external fibre cables beyond 2 metres from the building entry point. Your FBC can provide more guidance if needed.

Internal fibre cable must not be bent beyond its minimum radius. If it has been damaged or there is evidence of kinking it shall be discarded. Your FBC will advise on replacement of the cable.

Care should be taken to avoid stretching cable/tubes through installation. If cables are damaged this way you will be required to replace them.

7 Commercial units

Small or Medium Enterprise (SME) unit on a residential development

Single ended internal fibre cable (ezbend)

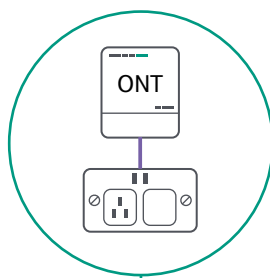
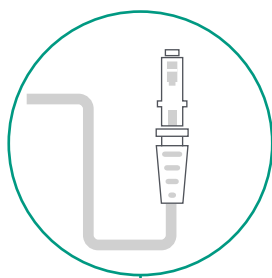

Please note
The ONT position within the building is to be agreed between the FBC and the developer on site.

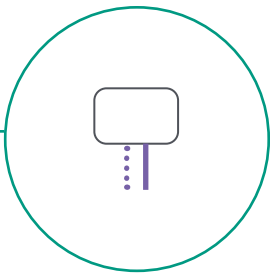
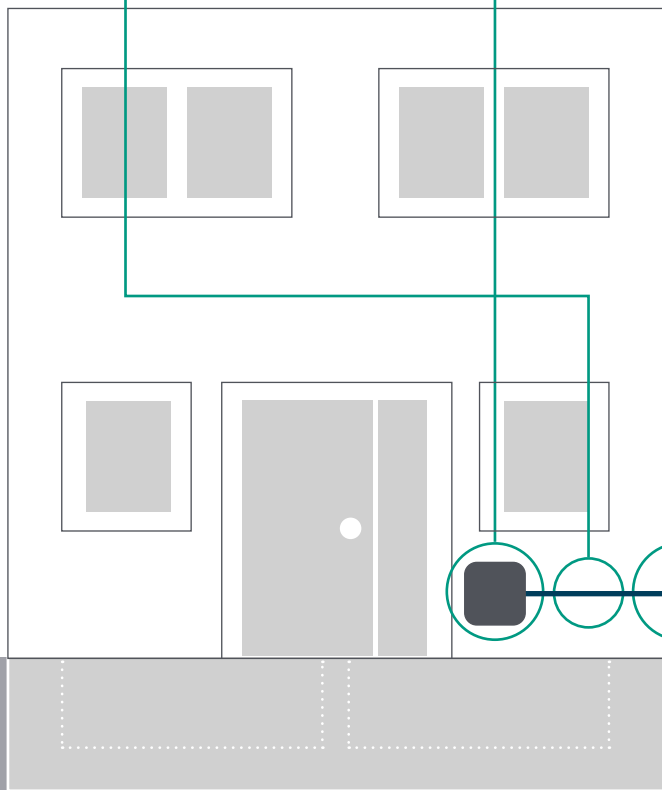

External capping

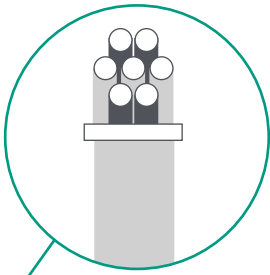

External fibre cable

Footway box

Commercial units

SME within an MDU

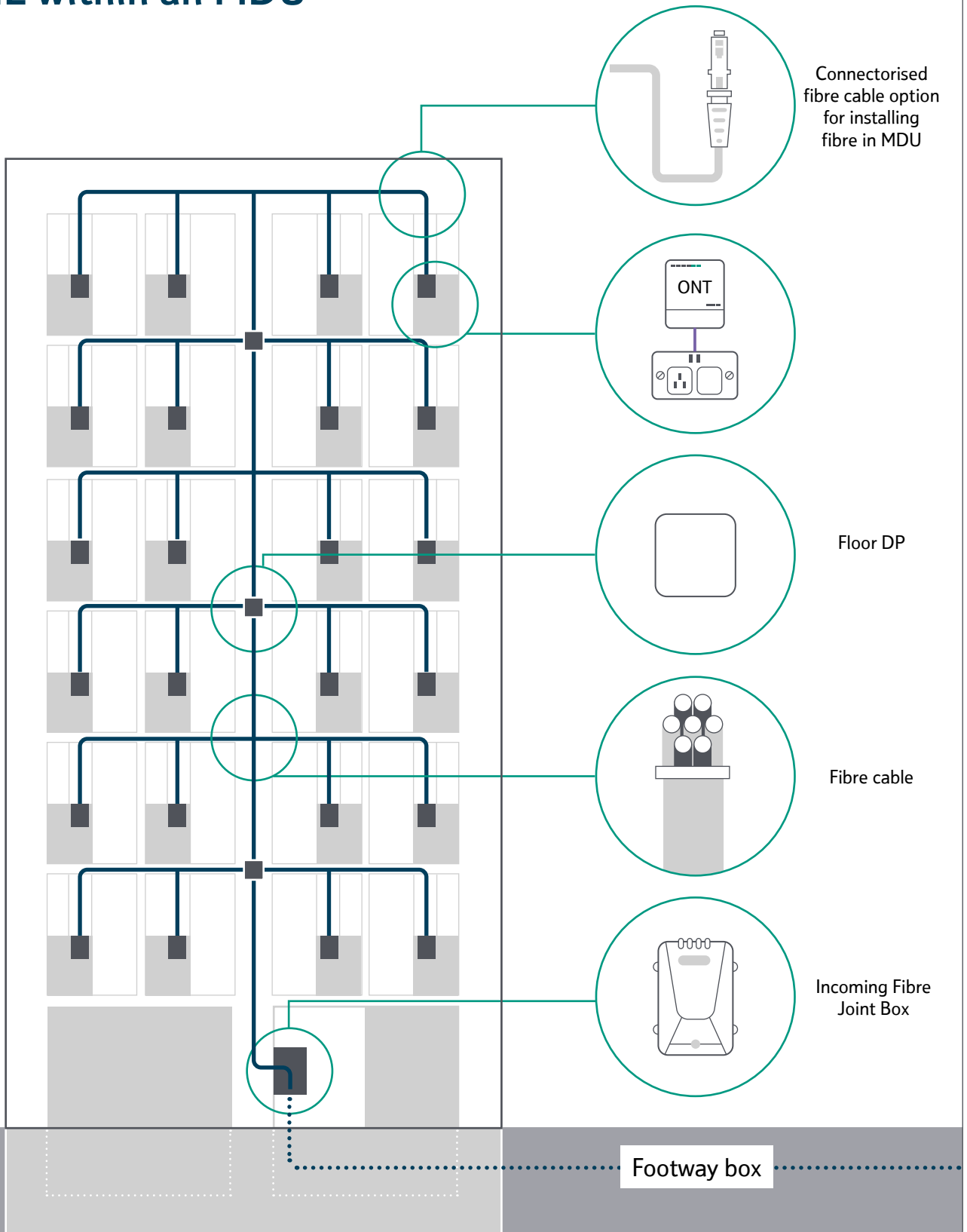

Commercial units

Commercial unit within a commercial only site

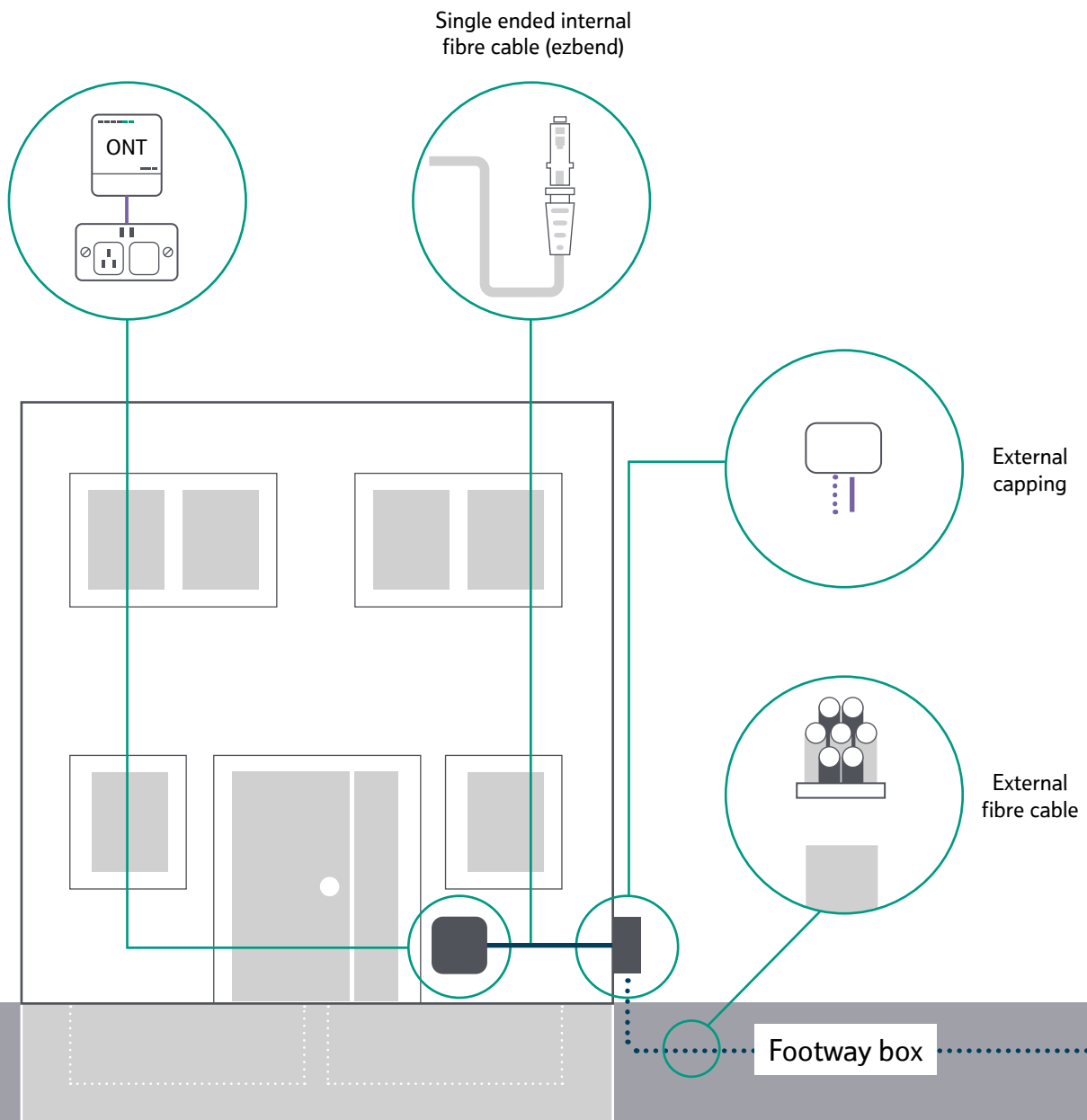

8 Duct laying

Carriageway Road Crossings

Where our duct crosses a carriageway, adjoining kerbs must be temporarily marked to note positions. Openreach duct must be laid on an outer edge of the service trench to enable box building. A draw rope will be inserted through the duct and secured to the marker posts at both ends of the crossing. The appropriate Plug Duct 4B socket end and 4C Spigot is then fitted.

Duct laid beneath a carriageway crossing must be a minimum of 450mm depth from the cover of the final surface levels and, for engineering reasons (Streetworks UK), separated from other services laid in parallel by 450mm (to permit us to install underground joint boxes without the need for bends).

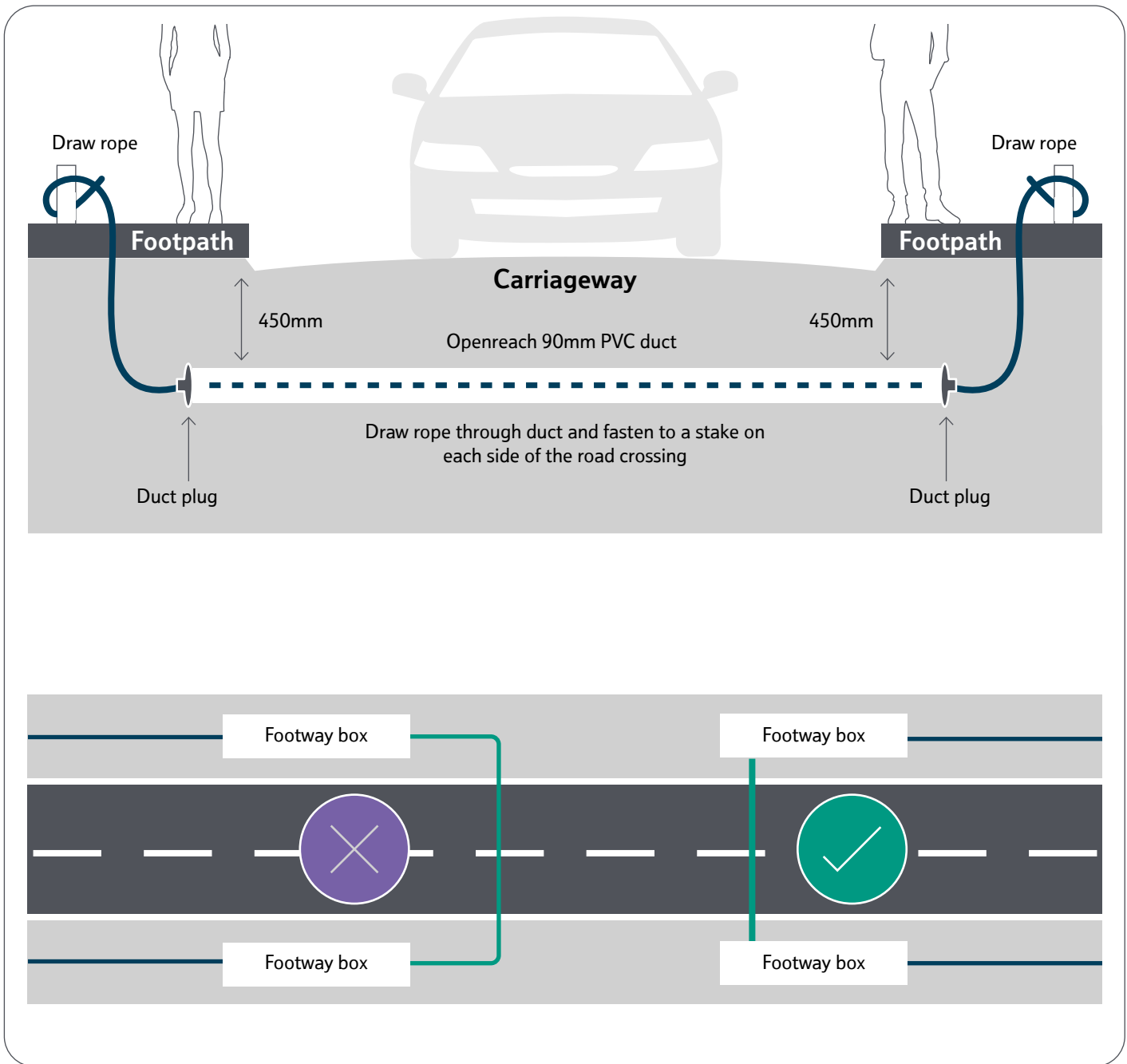

Duct laying

Ducting to the building

Duct to the premises/building must be laid at a minimum depth of 250mm and be as straight as possible.

Ducting general principles

- All runs shall be laid as straight as possible. If needed, you can carefully bend the ducts or use pre-formed bends supplied by Openreach.
- There shall be no more than one pre-formed 90° bend in any single run of duct.
- Pre-formed 90° bends shall not be installed in any duct linking two joint boxes.
- Footpath or service strip ducting must be laid at a minimum of 250mm depth of cover.
- All space alongside the duct must be backfilled with granular fill to a minimum thickness of 75mm.
- For all single dwelling units (SDU) duct must be terminated on the **external surface** of the property.
- The duct termination point must be in a location that will allow unrestricted access for any future maintenance activity.
- All ducts must be provided with a draw rope after installation, unless it's agreed locally to substitute the draw rope with a cable.
- Please notify your FBC when the duct has been laid and is ready for inspection.

Any internal duct feed must be sealed to prevent gas or water ingress. The required sealant can be provided by your Openreach FBC.

Commercial unit ducting

- 90mm duct can be laid either externally or internally to the building, with 90 degree angled bend.
- If internally then the duct should be sealed once cabling is complete – the FBC will provide this as a stores item.
- The termination point on a large commercial unit within a commercial only site should be located within 10m of the entry point.

Detectable Buried Service Warning Tape

- Traceable warning tape must be installed on your site above all new duct and direct-in-ground cable as no locator signal can be sent over fibre cables.
- Warning tape with a traceable wire running through it will allow other utilities to locate our network prior to excavation and help our Plant Protection Officers accurately mark-up network positions.
- Tape must be placed 50mm above the installed duct or cable, in footways and carriageways.
- Installation of tape on site falls under current SOD rebate requirements.
- Tape will be ordered by your FBC alongside other free issue materials.
- Tape is a newly introduced item, therefore to locate existing cables on site please follow the existing guides and processes on locating our network on our website: openreach.com/building-developers-and-projects/locating-our-network

Please note

The latest information on the positioning of utilities, mains and plant can be obtained from Streetworks UK: streetworks.org.uk

Duct laying

Arrangement of mains services

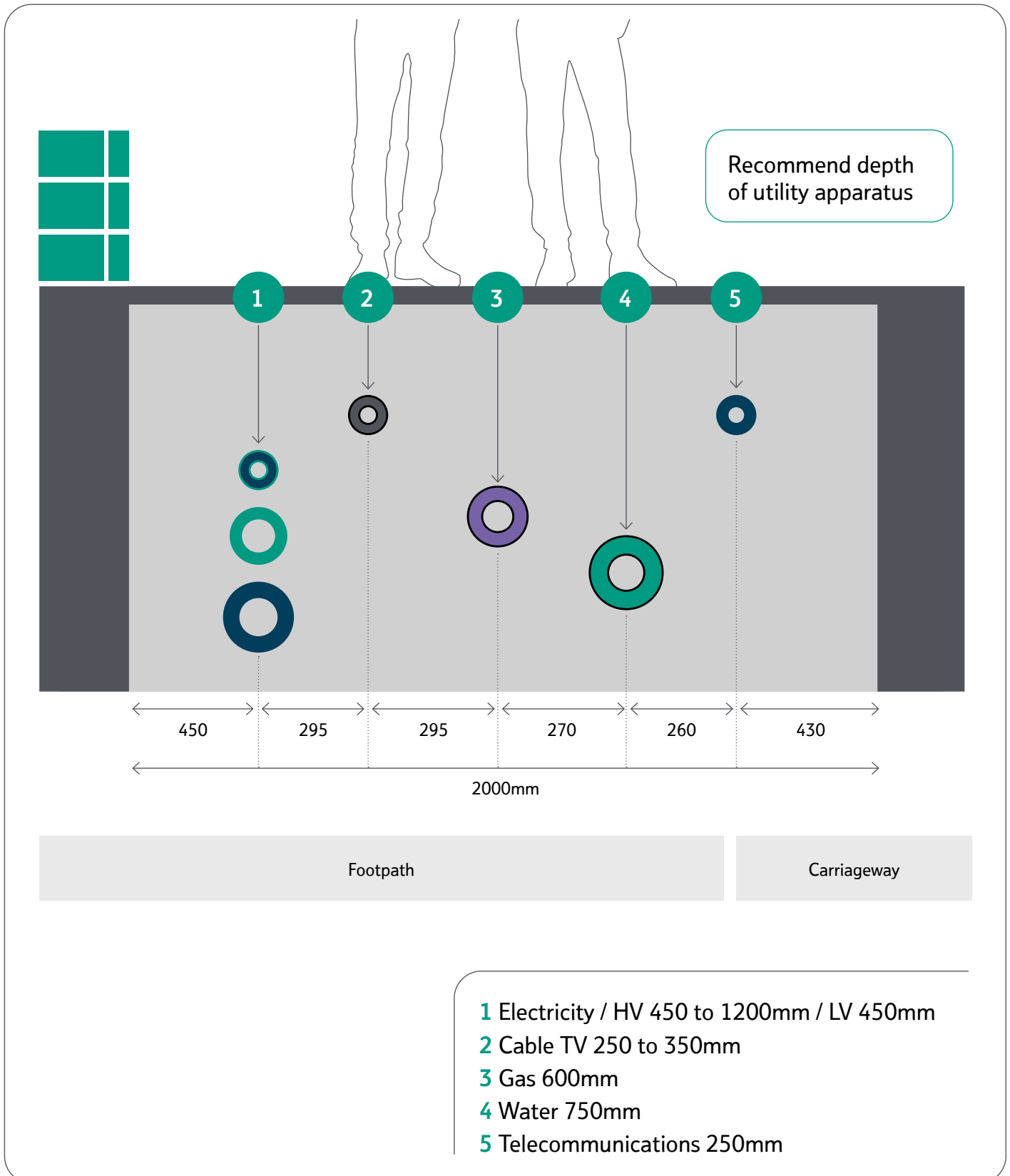

Duct laying

Avoiding damage to the Openreach underground network

Openreach has an extensive underground network that can be located inside/on the perimeter of a site.

This network is vulnerable to excavation related damage unless appropriate precautions are taken.

The precautions for avoiding damage to an underground utility plant are contained within the Health & Safety Guide no. 47: “Avoiding danger from underground services”.

Available here:

hse.gov.uk/pubns/books/hsg47.htm

This document stresses the need for the availability of utility plans on site and the use of safe digging practices.

Damage to the Openreach network by a third party can be expensive for that party to repair.

By working together, we want to make sure you avoid the repair and associated cost which can consist of one or more of the following:

- **Direct Cost** – the cost of repair.
- **Operational Cost** – delays associated with repair.
- **Social Cost** – loss of service to emergency services/centres or the vulnerable in society.

Typical issues with carriageway road crossings

- Insufficient depth.
- Proximity to other services.

Impact of issues

You will have to renew duct and this may delay any first occupation date or subsequent occupation dates.

Click Before You Dig

To obtain a more precise location of Openreach infrastructure (either within your site or the adjoining land) and avoid costly damage, email cbyd@openreach.co.uk

Utilisation of the Openreach “Click Before You Dig” free service has a proven record of minimising the potential for damage and cost.

If you need to move or consult on existing Openreach equipment, contact us on **0800 783 2023** or complete the online webform at: openreach.com/help-and-support

9 Modular jointing chambers – Quadbox™

The optional approved pre-formed chamber system Quadbox™ can be used to speed up the installation process and bring significant productivity benefits as there is no need for specialist box building teams and concrete backfill to be used.

The Quadbox™ is not a free stores item from Openreach, but can be purchased directly from our approved supplier, Radius Systems. For purchasing enquiries please contact the sales and marketing manager for Radius at the following details:

Sandra Davoust McCann

Email: [Sandra.DavoustMcCann@](mailto:Sandra.DavoustMcCann@radius-systems.com)

radius-systems.com

Tel: +44 (0)28 3844 6060

Quadboxes can also be sourced from a number of nationwide builders' merchants. This may be more suitable for smaller sites that need lower quantities.

Joint box modular footways 104 and 106 are the Openreach approved versions (BT specification LN712). Box furniture items slot into moulded pockets within the chamber, eliminating the need to cast-in fixings or drill on site. Duct entries are also easy to achieve, using a standard hole saw mounted on a cordless drill.

The lightweight high-strength system is supplied as 150mm deep twin wall high-density polyethylene (HDPE) rings to provide maximum flexibility and strength which are simply stacked on a prepared base and backfilled with suitable as-dug or Type 1 material.

See the suppliers Installation Guide which comes with your box. If purchasing a pre-formed chamber please speak to your FBC who can order all associated box furniture.



Modular jointing chambers – Quadbox™

Furniture

Cable brackets and steps (where required) are supplied in a bagged kit and easily slot into purpose designed pockets in the chamber. The brackets and steps drop into preformed slots.



Available Size Range

Product Code	Clear opening	Depth Per Section
JMF104	915X445mm	150mm
JMF106	1310X610mm	150mm

At least 5 sections are needed to meet the minimum box depth of 750mm.

Modular jointing chambers – Quadbox™

Duct entries

Duct entries can be cut as and where required using a hole saw mounted on a cordless drill.

The chambers incorporate guides which identify drilling points to ensure correct duct spacing.

A maximum of 4 duct entries can be made into a single wall of the Quadbox™.



Camber Adjustment

If the frame requires levelling to the ground surface, or to a newly raised surface level, rising frame units (as shown) are available as an option. These should be used in conjunction with mortar to build the frame up to the required level. Where levels mean that the cover needs raised by more than the 50mm allowable mortar bed, bricks, quarry tiles etc. should not be used to adjust the height of the cover.

A further Quadbox section should be cut horizontally (minimum depth to be a 40mm wall section), with the voids of the cut chamber filled with C32/C40 concrete or mortar.



Quadbox points of note

As with brick built chambers, care should be taken to make sure:

- The box is set at the correct depth and the base/plinth is installed correctly.
- The side wall is not damaged/misshapen due to over compaction.
- The frame is level with the surface and a core drill is used for cutting duct entries.
- The wall bearers are provided by Openreach and can be ordered by your FBC.

10 Joint boxes, footways and frames & covers

Footway (JBF104/106)

Joint box designs and specifications may vary depending on the duct layout and whether multi-way ducts or major road crossings need to be incorporated into the network design.

Full technical drawings and specifications for all joint and footway boxes can be found at openreach.com/fibre-broadband/fibre-for-developers/guides-and-handbooks

Materials

- **Bricks:** BS EN771-1. Stretcher Bond.
- **Cement:** BS EN197-1:2000 ordinary mix. Three parts sand to one part cement.

Specifications

- **Base:** 150mm concrete, clean and level.
- **Brickwork:** Keyed in at the corners and pointed.
- **Frame and cover:** Set on a mortar bed and fitted squarely to the box structure. You can purchase lifting keys for the covers from TW Engineering Co Ltd at www.twtools.co.uk (tel: 0115 932 3223).
- **Duct entries:** Must not enter through corners and be no less than 75mm from the side wall. They shall enter wall at a minimum depth of 250mm from the top of the frame, cut flush and clear the base by a minimum of 100mm.
- **Bolts:** Must be fitted in each box to allow ironwork to be installed by the developer.
- **Step(s):** One step is required in all boxes deeper than 700mm.
- **JBF104(C):** 915mm(L) x 445mm(W) x 750mm(D).
- **JBF104(D):** 915mm(L) x 445mm(W) x 900mm(D) the minimum depth for boxes either side of road crossings.
- **JBF106(C):** 1310mm(L) x 610(W) x 750(D).
- **JBF106(D):** 1310mm(L) x 610(W) x 900(D) the minimum depth for boxes either side of road crossings.
- **All backfill material** to be class 6N type.
- **Workmanship, materials and method of construction** are to comply with all current relevant contract documents, British Standards and codes of practice for the construction industry.
- **Concrete** to be grade C32/40 with a water cement ratio 0.4 minimum. Cement content 380kg/m³. Aggregate maximum size 20mm. All in accordance with BS8500.
- **All ducts** shown are based on maximum recommended values for Duct Type 54D.
- **End ducts** to be inline.
- **Ducts** to be positioned not less than 75mm from a side wall.
- **Mesh** to be grade B500B or B500C conforming to BS4483.
- **Short lengths of Duct 54D 90mm** to be used on non-ducted routes. Appropriate duct to be used on ducted routes.
- Where instructed to do so drill one set of three holes using a 12mm **masonry drill** bit to a depth of 80mm for future fitting of equipment mounting bracket.
- For details and specs on using corbelling visit the [link](#) at the top of this page.

Please note

At no time must minimum box depth be compromised. Consult your FBC if the minimum depth cannot be achieved.

Joint boxes, footways and frames & covers

Joint box footway 104 – the preferred option

Internal dimensions. Brickwork Stretcher Bond.

Dimensions in mm (not to scale).

- Maximum depth 900mm

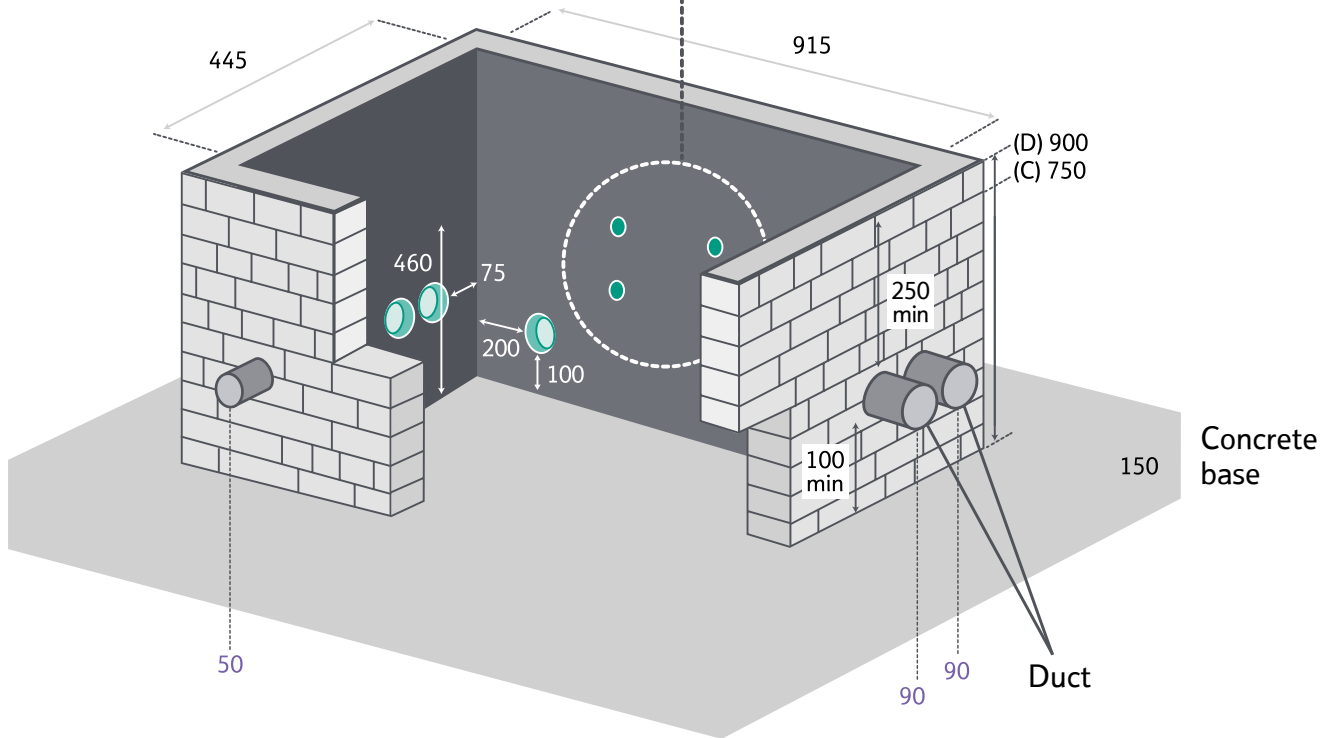
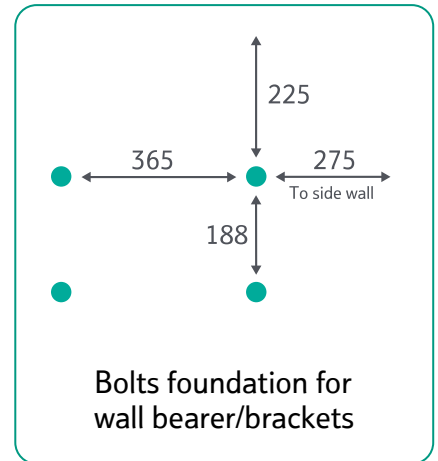

Joint boxes, footways and frames & covers

Joint box footway 106

Internal dimensions. Brickwork Stretcher Bond.

Dimensions in mm (not to scale).

- Minimum depth for road crossing 600mm
- Sump to be fitted in boxes deeper than 700mm

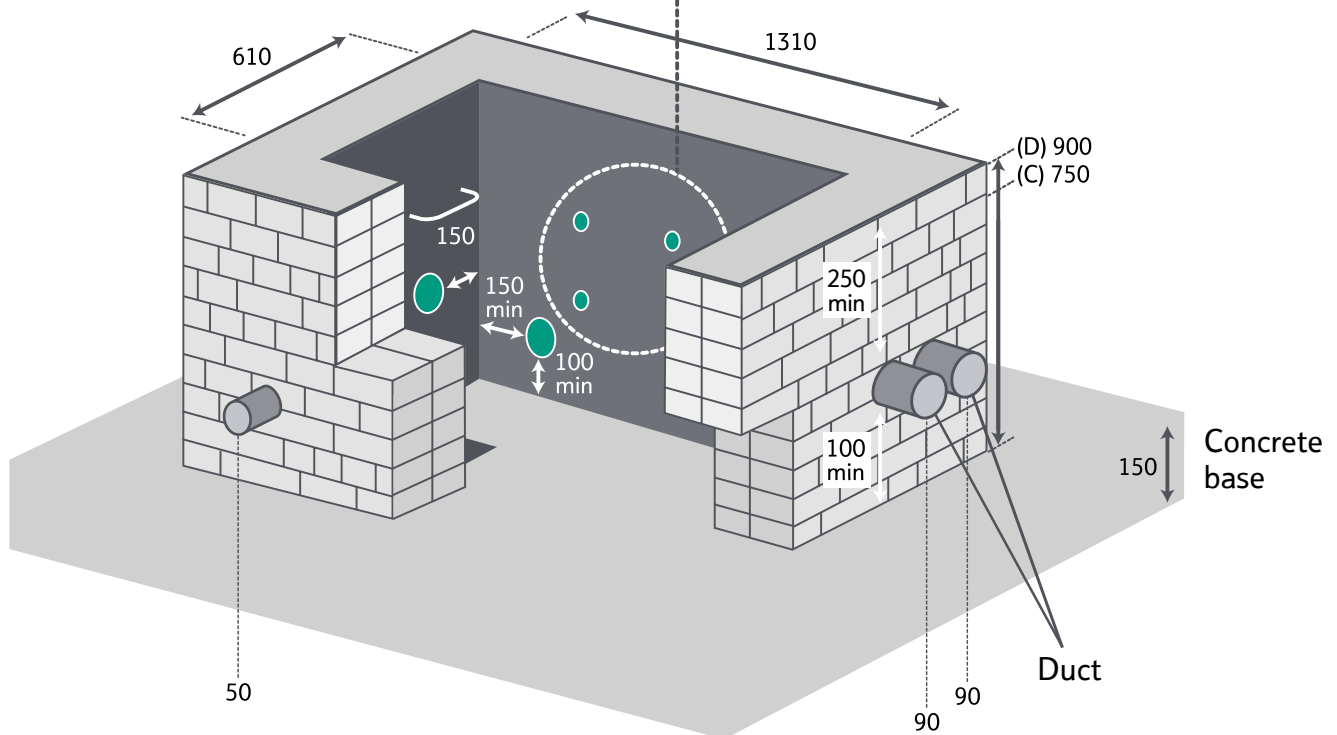
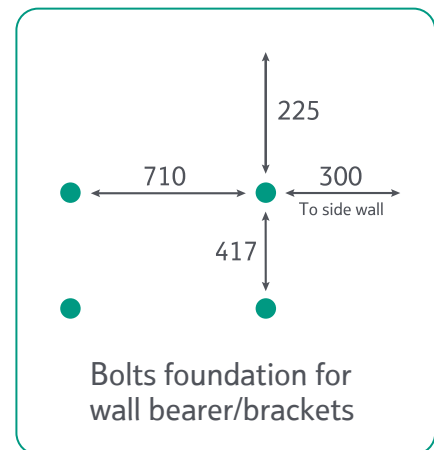

Joint boxes, footways and frames & covers

Carriageway boxes

Full technical drawings and specifications for all carriageway boxes can be found at openreach.com/fibre-broadband/fibre-for-developers/guides-and-handbooks

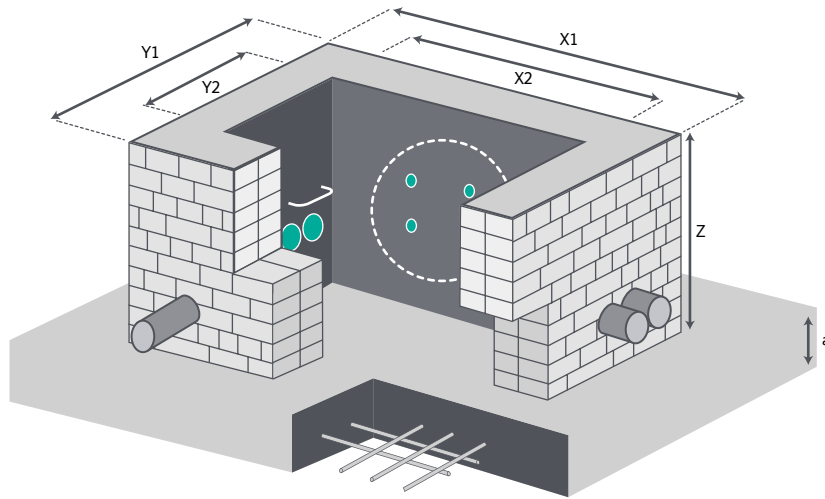

Box Type	Box Dimensions (mm)					
	Excavation Size		Box Opening Size		Z	a
	X1	Y1	X2	Y2		
JBC2(N)	1650	1110	1220	680	Min Depth 635 Max Depth 900	225
JBC3(N)	1040	1040	610	610		150
JBC4(N)	1345	875	915	445		200

Materials

- **Bricks:** Minimum Class B Engineering Bricks, BS EN1996
- **Cement:** BS12:1996 – Specification for Portland cement
- **Concrete:** C35/45, BS EN206
- **Mortar:** Class (iii), 1:5 CEMENT:SAND ratio (max) or 1:1:5 CEMENT:LIME:SAND

Base

- **Cement:** BS12:1996 – Specification for Portland cement
- **Concrete:** 1 layer of A393 mesh to top face of base slab. Minimum 55mm cover to any face. B500B or B500C, BS4483

Brickwork

- English bond, flush pointed

Frame and cover

- Frame cover to be installed to DMRB CD534 installation practices

Lifting keys

- Key Joint Box Lifter should be used to lift the cover and can be purchased from TW Engineering Co Ltd at www.twtools.co.uk (tel: 0115 932 3223) or similar supplier of your choosing

Ducting

- Duct to be cut flush to the internal box wall
- Duct must not enter through corners and be no less than 75mm from the side wall
- Duct to enter wall no less than 450mm from the top of the frame

Joint boxes, footways and frames & covers

Frames and Covers

Cubis Industries is the only supplier of these Openreach approved products.

Only approved frames and covers shall be fitted on your site. They are identifiable by the following markings; 'EN24 B125' the British Standards kitemark the Manufacturer Mark (SID), the year of manufacture and the BT identifier.

The 'standard frames and covers' are supplied by Openreach. They consist of a galvanised steel fabricated frame, fitted with unfilled galvanised steel fabricated cover trays and cross-beams.

All covers can be fitted to brick or concrete.

Please note

Where there's evidence or high risk of vehicles using the soft verge e.g. as an undertaking area opposite a T-Junction, a passing point on a narrow road or a parking area, it will be necessary to install a 'carriageway chamber, frame and cover'. **There is also an optional 'recessed frame and cover'.**



Recessed frames and covers

These can be purchased by the installer as an option to the 'standard frame and cover'.

Each cover tray has two key-hole fittings (in the centre of the short side) one of which carries a BT identity mark and the manufacturers' three letter identification 'SID'. The other key-hole fitting displays EN124 and B125 together with the BSI Kite mark certifying the covers to BS EN124: 1994. Recessed frames and covers will accommodate infill blocks to a maximum depth of 60mm. If you're planning to install frames and covers that aren't supplied by Openreach e.g. for block paving, or you have any doubts about what frames and covers to use, please speak to your FBC.



Joint boxes, footways and frames & covers

Installation

All frames and covers shall be levelled to the final running surface.

Where a box is located within grass, soft or unmade surfaces, the frame shall be surrounded with a 100mm wide strip of minimum grade C25/30 concrete, to the full depth of the frame, finished level with the top edge of the frame and the outside edge. It must be straight and parallel to the frame.

Unapproved frames and covers

Unapproved frames and covers must not be fitted. Openreach will take any necessary action against any developer who fits unapproved frames and covers within the network, including any potential claim for damages and costs, with possible delayed Service On Demand (SOD) payments. If you're unsure how to specify approved covers, please contact your FBC.



Dropped kerb and shared surface chamber boxes

If your site has shared surfaces for roads and footways, please ensure the correct joint box is installed based on the following guidelines.

- There must be a defined kerb line between the road and footway to install a footway spec box or modular quadbox in the footway area
- If no defined kerb line is present, a carriageway spec box must be installed as regular traffic could pass over these areas
- Driveways attached to houses and entrances to service areas do not require a carriageway spec box, so footway and modular quadboxes can be used for these areas



Example of a defined kerb line on a shared surface

11 List of abbreviations and acronyms

Openreach maintains that all reasonable care and skill has been used in the compilation of this publication. However, Openreach shall not be under any liability for loss or damage (including consequential loss) whatsoever or howsoever arising as a result of the use of this publication by the reader, his servants, agents or any third party.

In the event of a discrepancy between the contents of this document and the contract, the terms and conditions shall take precedence. This is a living document and will be subject to update and change. The information within this document is provided for information purposes only. The Contract and Price List takes precedence.

BSI	British Standards Institute
BT	British Telecommunications
CLI	Customer Lead In
CP	Communications Provider
DP	Distribution Point
FDP	Fibre Distribution Point
FTTP	Fibre to the Premises
FBC	Field Based Coordinator (formally New Site Representative)
HDPE	High-Density Polyethylene
IET	Institute of Engineering and Technology
JBC (N)	Joint Box Carriageway New Sites
JBF	Joint Box Footway
LSZH	Low Smoke Zero Halogen
MDU	Multiple dwelling unit
MJF	Product code designation for the Cubis Industries–StakkaBox/Quadbox
M&E	Mechanical & Electrical
NJUG	National Joint Utilities Group
NTE	Network Terminating Equipment
NTP	Network Terminating Point
ONT	Optical Network Termination
PAS	Publically Available Specification
PE	Polyethylene
PVC	Polyvinyl Chloride
RFH	Reduced Fire Hazard
SID	Manufacturers three letter identification
SDU	Single dwelling units
SOD	Service on Demand
UG	Under Ground

12 Health and safety advice

This guidance is a practical aid for designers and site workers on what to eliminate, avoid and consider when working on the Openreach network on your site.

The advice is not exhaustive so speak to your Field Based Co-Ordinator (FBC) if you need further information.

Red lists

Hazardous procedures, products and processes that should be eliminated from the project where possible

Distribution point (DP) location

- Placing DPs into voids or other enclosed spaces with inadequate ventilation.
- Placing DPs adjacent to, or above, any fragile surface.
- Placing DPs directly above, or adjacent to, water features/courses etc.
- Locating DP at greater than 1.5 meters above finished floor level (without fixed access system incorporated into design).

Power systems

- Ensure all power installation meets relevant standards, and where DC supplies are planned seek further advice about requirements for earthing of racks, power supply ratings etc. to take account of future needs and growth.

Cabling routes and lead-ins

- Routing of cables where the cables are above head height within false ceiling systems without a proper access system incorporated.
- Routing of cables external to building requiring specialist access methods (scaffold, mobile elevating work platform etc.)
- No internal ducting laid into single dwelling units (SDUs).

Aerial and antenna transmission/receiver systems

- Not mounted on building walls or other difficult to reach areas of a building.
- Design of roof mounted services that require access (for maintenance and so on), without provision for safe access (such as barriers) in particular access for aerials/antennas systems.

Joint boxes, footways and frames & covers

Amber lists

Products, processes and procedures to be eliminated or reduced as far as possible and only specified or allowed if unavoidable. Including amber items would always lead to the provision of information to the principal contract or contractor where only one contractor has been appointed.

Distribution point (DP) location

- DPs located into voids or enclosed spaces provided with ventilation systems built in.

Aerial and antenna transmission/receiver systems

- EMF exclusion zones adequately managed with fixed barriers or partitioning systems.

Cabling routes and lead-ins

- Routing of cables where the cables are above head height within false ceiling systems.
- Routing of cables internally where access points require use of access equipment (ladders, step-ladders or platform steps) to allow for pulling in of cables.

Green lists

Products, processes and procedures to be positively encouraged.

- **Adequate access for vehicles** to minimise reversing requirements (one-way systems and turning radii) in particular if specialist vehicles will need access (pole erection units, MEWP vehicles etc.).
- **Provision of adequate access and headroom** for maintenance in communications rooms, and adequate provision for replacing heavy components.
- **Thoughtful location of mechanical and electrical equipment**, such as telecoms equipment, termination points, Wi-Fi transceivers etc. and so on to facilitate access, and placed away from crowded areas.
- **Lighting within communications rooms** adequate for fine tasks (fibre splicing, small diameter copper wire terminations etc.)
- **Provision of adequate air handling/conditioning and ventilation** for the installed equipment base within the communications room (and people having to access and work within the area).
- **Early installation of permanent** means of access, and prefabricated access systems with hand rails.
- **Provision of edge protection** at permanent works where there is a foreseeable risk of falls after handover (consider radio antenna or aerials installations on roof spaces).
- **Encourage the use of engineering controls** to minimise the use of personal protective equipment.

13 Quality control checklist

To help make sure your site network is built to a high quality standard, we've produced a checklist for each phase of the build. Your FBC will complete an online version of this checklist at each stage, this list can be used as a reference.

Any subsequent changes to the site plan after stages have been signed off must be communicated and agreed with your FBC as soon as possible.

Any re-work as a result of an out of date site plan could cause delivery delay and incur you costs in time related charges.

If you have any questions about your development, please visit: openreach.com/fibre-broadband/fibre-for-developers or call us on **0800 783 2023**

Item being audited	Category
Base has been cast correctly.	Joint Box
Reinforced base cast correctly for Joint Box Carriageway JBC (N).	Joint Box
Bearers and brackets fitted. Steps fitted where appropriate.	Joint Box
Bolts fitted and positioned correctly during construction of boxes.	Joint Box
Joint Box constructed to correct dimensions and installed at the correct depth. Any deviations to plan recorded and signed off.	Joint Box
All concrete/brickwork carried out as per developer 'How to' guide specification.	Joint Box
Cement and brick types used as specified or exceptions agreed and documented.	Joint Box
Frames and covers bedded and correctly installed (if unmade surface, Joint Box frame secured).	Joint Box
Joint Box constructed as planned, positioned correctly and conforms to drawings. Alternatives agreed and documented.	Joint Box
Modular box installed and prepared as per instructions.	Joint Box
Ducts properly trimmed and keyed when set in walls.	Joint Box
External cable/Blown Fibre Tubing (BFT) protected and sealed in Joint Box.	Joint Box

Quality control checklist

Item being audited	Category
Fibre cable and draw rope provided in sound condition and correctly jointed where applicable.	Duct
Cable/BFT left in planned location.	Duct
Correct rope/cables/tubing installed as per developer 'How to' guide.	Duct
Correct type of duct provided and used.	Duct
Duct laid in required position, at correct depth and installed in the correct position in the Joint Box.	Duct
Duct properly trimmed and keyed when set in walls.	Duct
Duct separation distance maintained, or exception agreement obtained and documented.	Duct
Ducts laid at minimum depth (250mm), or exceptions agreed and documented. (To be viewed in footway where possible, if not check via Joint Box).	Duct
Joint Box constructed as planned, positioned correctly and conforms to drawings. Alternatives agreed and documented.	Duct
Temporary duct seals fitted to agreed standard.	Duct
Ducts positioned correctly on external walls and in line with the cable entry point.	Duct

Quality control checklist

Item being audited	Category
Ducts positioned in line with the cable entry point.	Plot
Customer cable entries correctly positioned and provided.	Plot
External cable/BFT protected and sealed.	Plot
Duct seal Plug 1A fitted.	Plot
Back box installed at entry point.	Plot
Back box fitted at a usable depth, within close proximity to a double 240v outlet for FTTP services.	Plot
Location of unit entry point suitable for FTTP equipment.	Plot
The property has been designed to accommodate voice and data wiring in a convenient place for home owners to use FTTP services.	Plot
A permanent 240 volt supply is required for FTTP. Developer has been informed that no orders can be made or taken via a communications provider until all installation works of Openreach equipment into each plot has been completed and tested.	Plot
Voice and data cabling provided and terminated correctly for FTTP services.	Plot
If FTTP self install development ONT, all leads connected correctly and plot commissioned.	Plot
If self install not completed and Openreach completes all internal work then SOD payment for self install is not applied.	Plot

Quality control checklist

Item being audited	Category
All tubes or cables presented as per schematic diagram and capped.	Multi dwelling unit
Designated track ways/trays supports in good working order with separations maintained.	Multi dwelling unit
Connectorised fibre cable installed as per schematic in accordance with manufacturer's specifications and IET wiring regulations. Cable labelled and coiled safely within riser.	Multi dwelling unit
Connectorised fibre cable installed with 1m of spare length protruding from the back box to enable jointing.	Multi dwelling unit
Back box fitted in each unit at a usable depth, within close proximity to a double 240v outlet for FTTP connectivity.	Multi dwelling unit
Location of unit entry suitable for FTTP equipment.	Multi dwelling unit
If FTTP self install development ONT, all leads connected correctly and plot commissioned.	Multi dwelling unit
If self install but Openreach completed all internal work then SOD payment for self install is not applied.	Multi dwelling unit

14 ONT plot stickers

Plot #	ONT Barcode Sticker
1	
Address	
2	
Address	
3	
Address	
4	
Address	
5	
Address	
6	
Address	
7	
Address	
8	
Address	
9	
Address	

Plot #	ONT Barcode Sticker
10	
Address	
11	
Address	
12	
Address	
13	
Address	
14	
Address	
15	
Address	
16	
Address	
17	
Address	
18	
Address	

ONT plot stickers

Plot #	ONT Barcode Sticker
19	
Address	
20	
Address	
21	
Address	
22	
Address	
23	
Address	
24	
Address	
25	
Address	
26	
Address	
27	
Address	

Plot #	ONT Barcode Sticker
28	
Address	
29	
Address	
30	
Address	
31	
Address	
32	
Address	
33	
Address	
34	
Address	
35	
Address	
36	
Address	

ONT plot stickers

Plot #	ONT Barcode Sticker
37	
Address	
38	
Address	
39	
Address	
40	
Address	
41	
Address	
42	
Address	
43	
Address	
45	
Address	
46	
Address	

Plot #	ONT Barcode Sticker
47	
Address	
48	
Address	
49	
Address	
50	
Address	
51	
Address	
52	
Address	
53	
Address	
54	
Address	
55	
Address	

ONT plot stickers

Plot #	ONT Barcode Sticker
Address	
Address	
Address	
Address	
Address	
Address	
Address	
Address	
Address	
Address	

Plot #	ONT Barcode Sticker
Address	
Address	
Address	
Address	
Address	
Address	
Address	
Address	
Address	

ONT plot stickers

Plot #	ONT Barcode Sticker
Address	
Address	
Address	
Address	
Address	
Address	
Address	
Address	
Address	

Plot #	ONT Barcode Sticker
Address	
Address	
Address	
Address	
Address	
Address	
Address	
Address	
Address	

15 Psychological Infrastructure Access (PIA)

PIA allows non-Openreach network providers to share Openreach's network infrastructure, which on Full Fibre new sites consists mainly of ducts and chamber boxes. PIA can also be used to share telegraph poles as well as underground infrastructure.

PIA allows multiple network providers to deliver service on a new site development without requiring different ducts and chamber boxes for each service.

Non-Openreach network providers will have to be invited onto site by you as a developer to be a part of a PIA delivery, Openreach is unable to provide this initial contact. If you have a non-Openreach network provider interested in a PIA product, inform your Openreach FBC and they will guide you through the following steps.

- An initial site meeting between you the developer, your Openreach FBC and the non-Openreach network provider will be completed to discuss the PIA proposal
- Your FBC will share the required quality standards with you the developer and the non-Openreach network provider
- Your FBC will perform a series of checks to ensure the non-Openreach network provider has various requirements in place to allow the PIA product to be legally used
- Your FBC will confirm when the duct and chamber box work has been completed to allow the non-Openreach network provider to install their equipment

Please ensure your FBC is made aware of any non-Openreach network planned to be installed on site during your initial site visit to allow the above process to be followed.

More information about PIA can be found on the Openreach website:
[openreach.co.uk/cportal/products/passive-products/physical-infrastructure-access\(PIA\)](https://openreach.co.uk/cportal/products/passive-products/physical-infrastructure-access(PIA))

Notes

openreach

openreach.co.uk

The telecommunications services described in this publication are subject to availability and may be modified from time to time. Services and equipment are provided subject to British Telecommunications plc's respective standard conditions of contract. Nothing in this publication forms any part of any contract. Openreach and the Openreach logo are trademarks of British Telecommunications plc.

© British Telecommunications plc 2022. Openreach Limited.
Registered office: Kelvin House, 123 Judd Street, London WC1H 9NP.
Registered in England and Wales no. 10690039. Produced by Openreach.
Designed by Westhill.co.uk

PHME 87500